

GAINSBOROUGH HOME

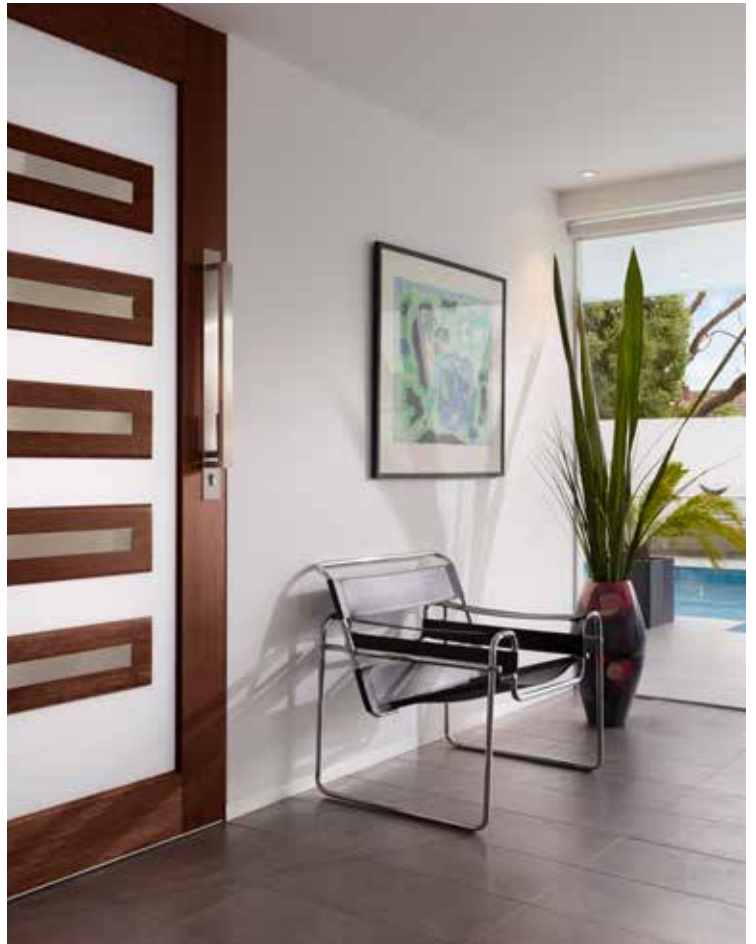



Welcome Home.

At Gainsborough we're all about opening a world of new style possibilities in door and access solutions.

For over forty years we have built our reputation on developing and producing leading-edge door hardware - innovative levers and locks that work silently to reflect your style and needs.

With our smart, design-savvy range, you can create a complete and harmonious look throughout your home that reflects your individuality and personal flair.

It goes without saying that with Gainsborough, you don't need to sacrifice style for security, because we know the most important thing isn't what's on your door, it's what's behind it.

For exterior doors

Contents

The right product for your home.

Gainsborough Home has access solutions for all of life's openings, each designed to keep working effortlessly through the years.

Making the right selection is important. Use the section guide to identify the application for your home and match this with the solutions available.



Finishes Legend

BC	Bright Chrome
BG	Bright Goldtone
BL	Black
BP	Bronze Pearl
BR	Brown
BZ	Bronze
GD	Gold
GR	Grey
LB	Lifetime Brass
MB	Matt Black
ML	Mill
PB	Polished Brass
PR	Primrose
PS	Polished Stainless Steel
SC	Satin Chrome
SL	Silver
SS	Stainless Steel
WH	White

For around the home

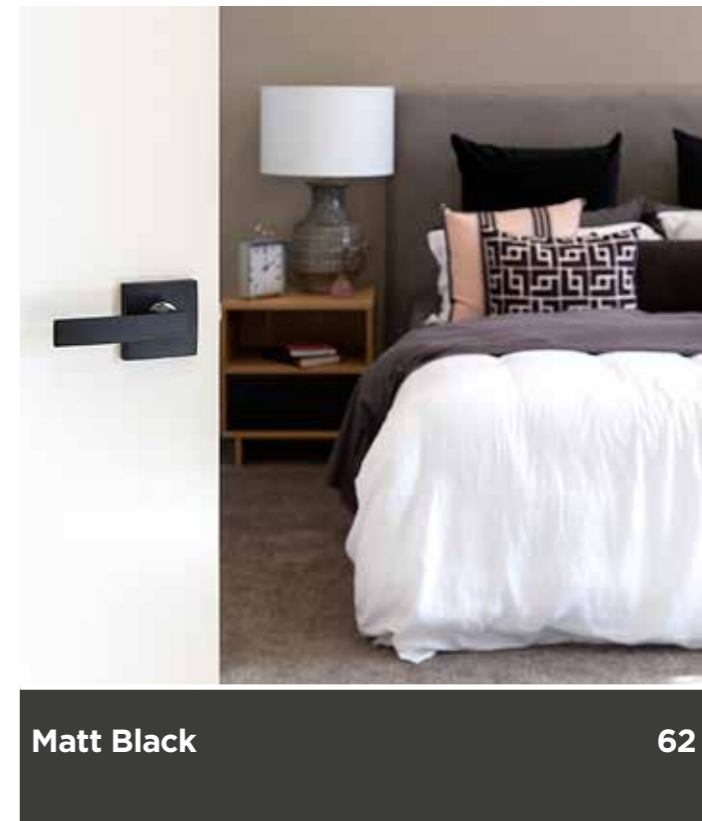

On trend

Selecting Your Product

Choose the right products for every application.

Gainsborough offers a broad range of products to suit applications throughout the home. The following shows a house plan and serves to indicate the Gainsborough products available to suit the relevant door in the home. Page numbers are also shown adjacent to the products concerned, in order to provide you with an easy to find reference guide.

Select the right hardware for your door.

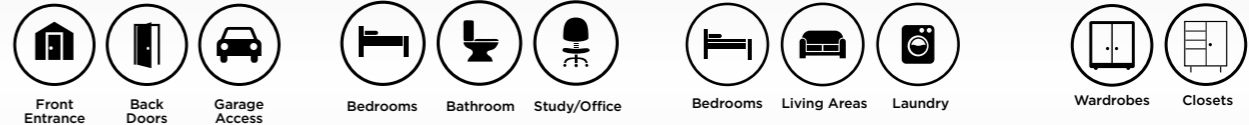

- ENTRANCE** (Red bar): For entrance and external doors you want to lock.
- PRIVACY SET** (Blue bar): For internal doors that you want to lock.
- PASSAGE SET** (Green bar): For internal doors that you don't want to lock.
- DUMMY LEVER** (Yellow bar): For non-operation wardrobe or closet doors.

Windows

Weatherstrips 61

General Interior Doors (non-locking)

Leversets 38-39, 41-45, 49, 64
 Knobsets 40, 48
 Classic Series 48-49
 Door Stops 58

Sliding Cavity Doors

Sliding Cavity Door Sets 52, 65
 Flush Pulls 53

Entry Doors

Electronic Access 8
 Trilock Series 12-17, 64
 Standard Entrance Sets 24-25
 Deadlocks 20-21
 Mortice Locks and Pull Handles 28-31, 65
 Door Stops 58
 Door Seals and Weatherstrips 60-61

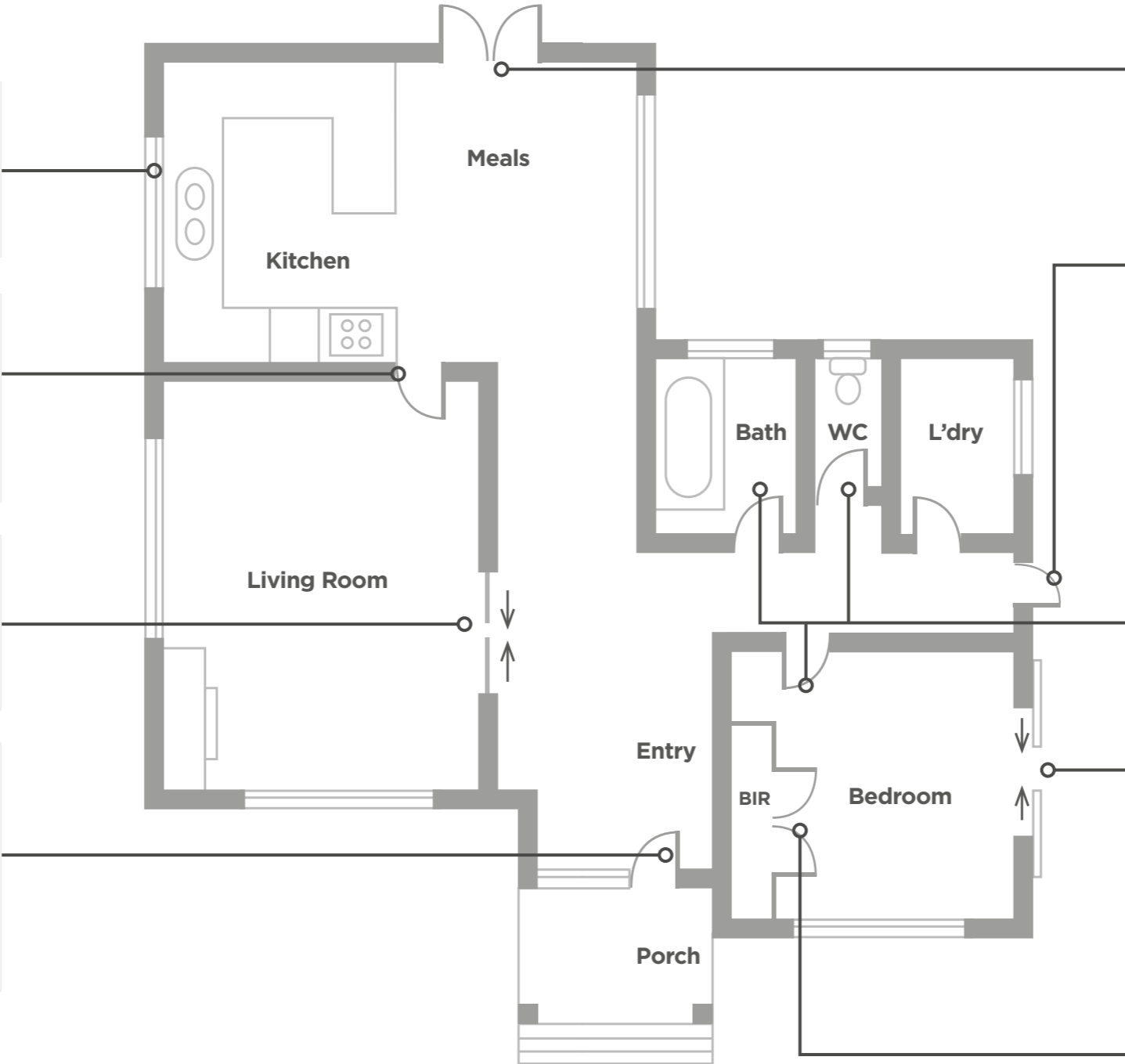

French Doors

Leversets 25
 Door Seals and Weatherstrips 60-61
 Flush Bolts 58
 Knobsets 24
 Deadbolts 20-21

Security Screen Doors

Hinged Security Screen Door Locks 34
 Pneumatic Door Closers 34
 Sliding Security Screen Door Locks 35

Interior Doors for Bedroom or Bathroom (where privacy locking is required)

Leversets 38-39, 41-45, 49, 64
 Knobsets 40, 48
 Classic Series 48-49
 Door Stops 58

Sliding Patio Doors

Patio Door Locks 35

Wardrobe or Cupboard Doors

Leversets - Dummy Levers 38-39, 41-45, 49, 64
 Knobsets - Dummy Knobs 40, 48
 Classic Series - Dummy, Wardrobe or Cupboard Knobs 48
 Flush Pulls 53



ELECTRONIC ACCESS

**Gainsborough's Digital
Entry Lever Lock
offers the ultimate in
convenience and security.**

You no longer need to carry around bulky keys. Entry is now made quick and easy using the illuminated keypad or by touching your entry tag. Gainsborough's Digital Entry Lever Lock is the perfect solution to upgrade your security at home.

ELECTRONIC ACCESS DIGITAL ENTRY LEVER LOCK



The new standard in digital locking solutions.



TOUCH ACCESS:

- Simply touch and go for speedy entry into your home
- Supplied with two entry tags, each lockset can be programmed to accept up to six entry tags



KEYPAD ENTRY:

- Digital keypad is programmable and features illuminated buttons for visibility and easy access
- A total of six user codes can be saved to operate each lockset
- 'One-time' user codes can be created for use by tradespeople, cleaners or your babysitter for added convenience and security



OTHER FEATURES INCLUDE:

- Manual key override - two mechanical keys provided for complete peace of mind
- Powered by four (4) AA batteries - no hard wiring required
- Additional entry tags can be purchased separately

DIY READY TO GO™

DIY READY TO GO™

The Gainsborough Digital Entry Lever Lock has been specifically designed for DIY installation to replace existing mechanical locks and fits standard 54mm holes.



DIGITAL ENTRANCE SET
PART NO. GDBSTE

Available finishes:
BC / SC



DIGITAL ENTRY TAG
PART NO. GDTAG

Available finishes:
N/A



3 IN 1 ENTRANCE SETS

TRILOCK™

Trilocks secure more new front doors in Australia than any other lock. Its unique 3 in 1 technology keeps your home private and secure.

Choose from the classic chic of the Trilock Traditional, the sleek, modern look of Trilock Contemporary, the minimalistic flat plated Trilock Eclipse through to the premiere in style and engineering, the Trilock Omni Pull Handle.

Trilocks set the standard from your front doorstep, inspiring you to express your signature style with complementary levers throughout your home. All Trilocks feature state of the art tarnish-resistant finishes that can be matched in look and feel to your favourite interior levers.



TRILOCK™

3 in 1 Security

Gainsborough Trilocks are unique in design, offering a combination of lockset, deadbolt and passage functions in the one system.

Three functions, one stylish lock.

Lockset with safety

Pressing the button on the inside of the door engages the Trilock lockset mode. This locks the door from the outside, however it is safe to exit without a key in an emergency by simply turning the inside knob or lever.

Deadbolt security

Trilock houses a key-operated double cylinder deadbolt, with a sturdy 20mm throw, to keep possessions and valuables safe whilst the home is unoccupied. (Single cylinder version features inside turn-button.)

Passage set convenience

When Trilock is unlocked and unsnibbed, it operates as a standard passage set, allowing free access in or out of the home.

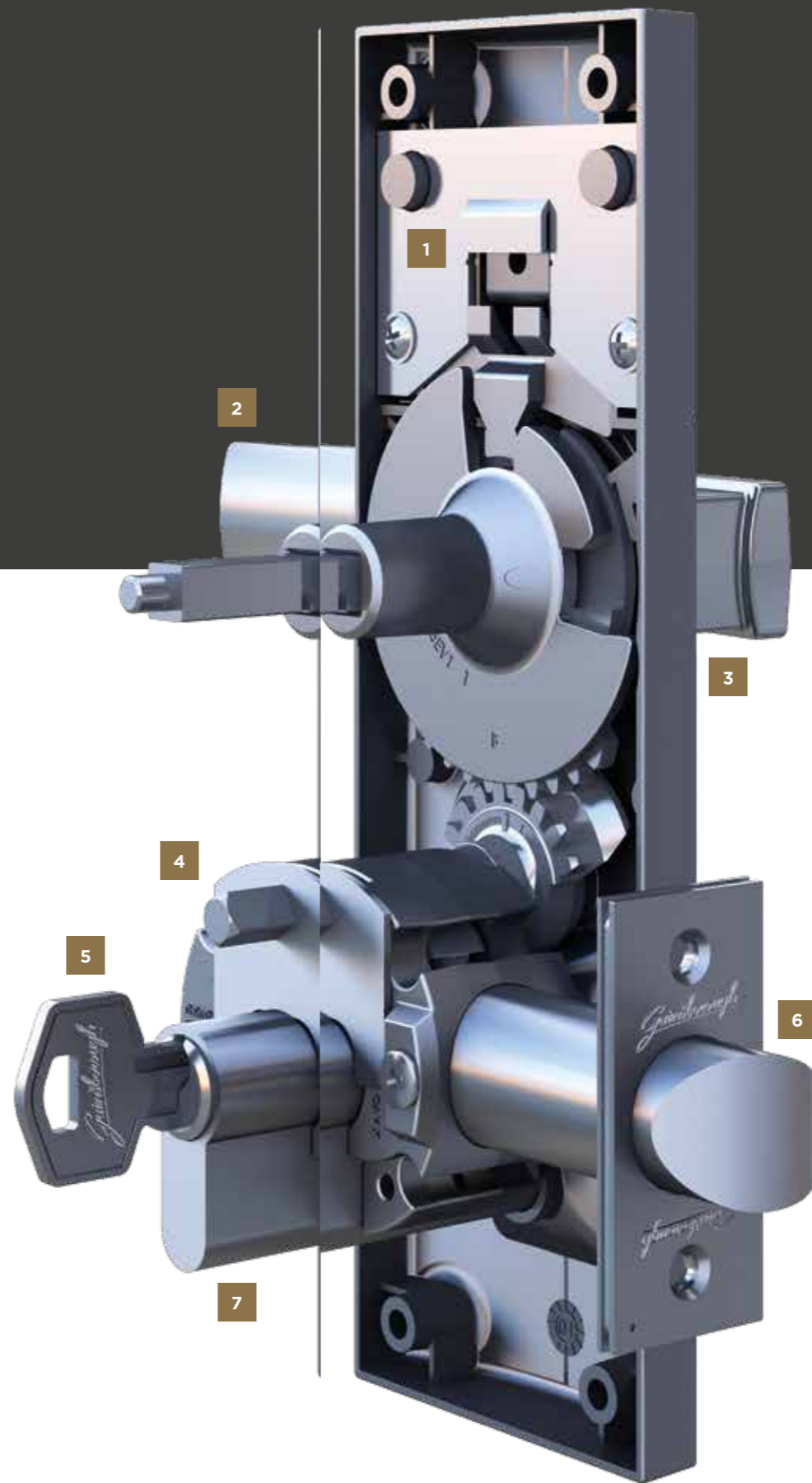

- 1 The push button lockset mode from inside of the door features panic release by simply turning the inside knob or lever.
- 2 Levers can be easily rotated during installation for use on left or right hand doors.
- 3 When unlocked and unsnibbed, Trilock operates as a normal passage set.
- 4 Lock body readily replaces old keylocks fitted to a standard 54mm hole.
- 5 Single handed operation (key operates all functions of the lock).
- 6 Deadbolt 20mm throw for extra security.
- 7 Solid brass double 5 pin Euro profile cylinder can be keyed alike to other Gainsborough products for same key convenience.

Exterior side	Interior side	
		Double Cylinder Key from either side will lock or unlock deadbolt.*
		Single Cylinder Key from outside or turn-button from inside will lock or unlock deadbolt.*
		Dummy Set A non-operational handle set for the fixed side of a double door.

* Also features other functions;
 • Push-button lockset mode
 • Passage set convenience when unlocked and unsnibbed

- 60mm backset
 - Suits doors 33-45mm thick



Gainsborough
Trilock
Licence No. 96313
Standards Australia

The Trilock '3 in 1' locking mechanism has been awarded with an Australian Design Mark® for Good Design by Standards Australia

G2 TRILOCK
SERIES TRADITIONAL



The Trilock Traditional Series combines timeless styling with advanced engineering, offering the choice of a knob or lever. The Trilock Traditional adds class to any home exterior and is available in Single and Double Cylinder options.



Knobset Trilock
PART NO. 890TRI

Available finishes:
BC / **BG** / SC



Leverset Trilock
PART NO. 890TLE

Available finishes:
BC / **BG** / **SC**

To facilitate the installation of a Trilock on a pivot door an Extended Strike Plate is available.

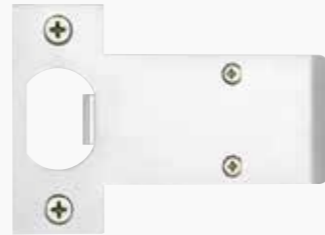

EXTENDED STRIKE - TRILOCK
PART NO. PT890/SPE1

Available finishes:
BC / **SC**



Single Cylinder
Internal view



Double Cylinder
Internal View

Trilocks are available in both Single Cylinder and Double Cylinder functions. The Single Cylinder option deadbolt can be unlocked by a key from the outside and a turn-button from the inside. The Double Cylinder option is unlocked by a key from both the inside and outside.

G2 TRILOCK
SERIES CONTEMPORARY



The Trilock Contemporary highlights modern design at its best, offering three streamline lever designs. Featuring concealed fixings, the Trilock Contemporary provides a sleek, modern finish and is available in Single and Double Cylinder options.



ALIGN TRILOCK
PART NO. 890IALI

Available finishes:
BC / SC



PRECISE TRILOCK
PART NO. 8901PRE

Available finishes:
BC / **SC**



ANGULAR TRILOCK
PART NO. 8901ANG

Available finishes:
BC / **SC** / MB

G1 TRILOCK
SERIES OMNI



The Trilock Omni makes a statement entrance featuring a 600mm pull handle with a cleverly concealed lever on the exterior side of the door. Internally, the flat plate Trilock Eclipse is available in three lever designs and is the perfect solution for a minimalist look. Available in Single and Double Cylinder options.



ROCHAS TRILOCK OMNI
PART NO. 8905ROC

Available finishes:
SS

ALLURE TRILOCK OMNI
PART NO. 8905ALL

Available finishes:
SS / PS

ENCHANT TRILOCK OMNI
PART NO. 8905ENC

Available finishes:
SS

G1 TRILOCK
SERIES ECLIPSE

The Trilock Eclipse accentuates the modern features of your home with designer flat plates on both exterior and interior sides of the door. Features a quality Stainless Steel finish across three designer levers. Available in Single and Double Cylinder options.

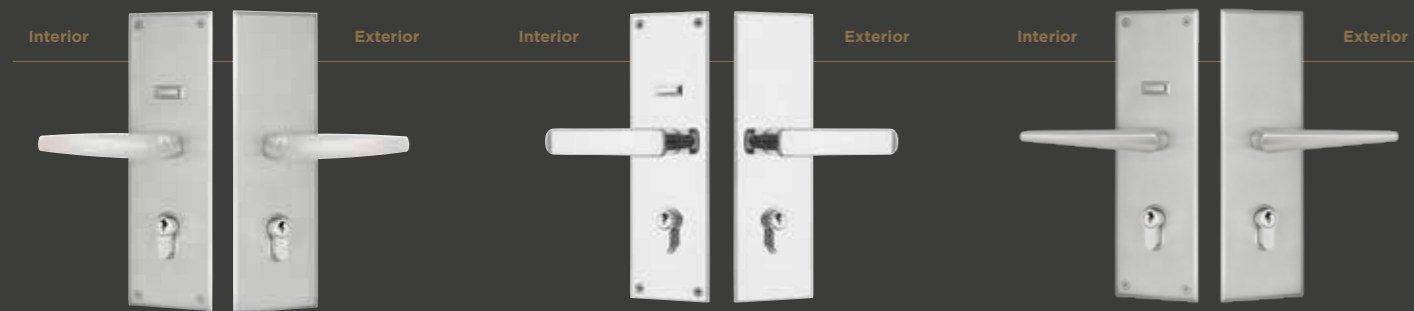

ROCHAS TRILOCK
PART NO. 8904ROC

Available finishes:
SS

ALLURE TRILOCK
PART NO. 8904ALL

Available finishes:
SS / PS

ENCHANT TRILOCK
PART NO. 8904ENC

Available finishes:
SS

Accentuate
the modern
features of your
home with the
designer range
of **Trilock Omni**
and **Trilock
Eclipse**.

EXTERIOR VIEW

External pull handle
with concealed lever
behind the pull handle.



Trilock Omni in
Polished Stainless finish

G1 TRILOCK
SERIES OMNI -
BACK TO BACK



The Trilock Omni Back to Back allows you to truly enter with style and features a 600mm pull handle with a cleverly concealed lever on both the exterior and interior sides of the door. Omni provides the perfect fusion of leading style and superior function; the ultimate entrance solution.



INTERIOR VIEW

Interior pull handle
with concealed
lever behind the
pull handle.



SIDE VIEW

Back to Back pull
handle option on either
side of the door.

**TRILOCK OMNI
BACK TO BACK**
PART NO. 8905BB

Available finishes:
SS / PS

DEADLOCKS

Gainsborough's Deadlocks provide leading security with an elegant design option to protect what is important to you.

Available in both Single and Double Cylinder options for added convenience, Gainsborough's range of Deadlocks are designed to give you peace of mind knowing that your home is safe and secure while you're away.



G4 SERIES **DEADLOCKS**
G4 SERIES



Smart and Secure – complement your G4 Levers with a G4 Deadbolt in either Single or Double Cylinder.



DOUBLE CYLINDER DEADBOLT
PART NO. 550

Available finishes:
PB / PS / SS

G3 SERIES **DEADLOCKS**
G3 SERIES



Featuring a brass bolt, the G3 Deadbolt offers a further level of protection in either Single or Double Cylinder.



DOUBLE CYLINDER DEADBOLT
PART NO. 850

Available finishes:
LB* / PS / SS

DEADLOCKS
LOCRIGHT



Gainsborough sets the standard for security and functionality with the LocRight Double Cylinder deadlatch. Features lock status indication from both inside and outside the door for your safety and convenience.



LOCRIGHT LEVER
PART NO. LRLG51

Available finishes:
BC / SC

G2 SERIES **DEADLOCKS**
G2 SERIES



Superior styling combined with advanced engineering means that you don't need to sacrifice style for security with G2 Deadbolts. Available in either Single or Double Cylinder.



STEPPED DOUBLE CYLINDER DEADBOLT
PART NO. 1951ST

Available finishes:
BC / SC

SQUARE DOUBLE CYLINDER DEADBOLT
PART NO. 1851SM

Available finishes:
BC / SC

SMOOTH DOUBLE CYLINDER DEADBOLT
PART NO. 1951SM

Available finishes:
BC / SC



LOCRIGHT KNOB
PART NO. LRLG51

Available finishes:
BC / SC

STANDARD ENTRANCE SETS

Gainsborough's range of locksets are designed to be the perfect finishing touch for your home.

Available in both knob and lever designs, keyed locksets are designed for security and durability. A variety of designs and finishes means that your individual style begins from the moment you open the front door.





The Gainsborough Entrance Knobsets feature stylish knob designs and adjustable 60mm or 70mm backsets.



GOVERNOR ENTRANCE KNOB LOCKSET
PART NO. 840GOV

Available finishes:
LB* / PS / SS
Note: Warranty for this product is 5 year tarnish resistant & 10 year mechanical.



FIRST IMPRESSIONS ENTRY SET
PART NO. 885A

Available finishes:
LB* / PS / SS
Note: Warranty for this product is 5 year tarnish resistant & 10 year mechanical.



VILLA ENTRANCE KNOB LOCKSET
PART NO. 540VIL

Available finishes:
PB / PS / SS



TERRACE ENTRANCE KNOB LOCKSET
PART NO. 540TER

Available finishes:
PB / PS / SS



Featuring a variety of designs, the Entrance Leversets are the perfect finishing touch for today's homes.



TREVI ENTRANCE LEVERSET
PART NO. 540TRE

Available finishes:
BC / SC



AMBASSADOR ENTRANCE LEVERSET
PART NO. 540AMB

Available finishes:
BC / SC / PB



MAJESTIC ENTRANCE LEVERSET
PART NO. 840MAJ

Available finishes:
BC / SC / PB
Note: Warranty for this product is 5 year tarnish resistant & 10 year mechanical.



MORTICE LOCKS & PULL HANDLES

Make a statement every time you open your door with a Gainsborough Mortice Lock and Pull Handle.

Gainsborough's range of Pull Handles offer superior styling, and when selected with a Gainsborough Mortice Lock, combines to create unparalleled protection and security without compromising style. Coming home has never looked quite so good.

MORTICE LOCKS & PULL HANDLES

755 MORTICE LOCKS

Maintain a clean, minimalistic look with Gainsborough's concealed Mortice Locks, combined with Gainsborough door furniture products. Features a spring-latch and double throw 20mm deadbolt for added security. Specify 758 for Single Cylinder version. Extended strike plate to suit pivot doors available separately.



755 SERIES MORTICE LOCK DOUBLE CYLINDER
PART NO. 755

Available finishes:
SC

MORTICE LOCKS & PULL HANDLES

760 MORTICE LOCKS

Features a 57mm backset with a butterfly claw action deadbolt. Specify 768 for Single Cylinder version.



760 SLIDING DOOR MORTICE LOCK DOUBLE CYLINDER
PART NO. 760

Available finishes:
SC



REBATE KIT TO SUIT 760 SERIES SLIDING DOOR MORTICE LOCK
PART NO. 760RK

Available finishes:
SC

MORTICE LOCKS & PULL HANDLES

775 MORTICE LOCKS

Features a roller bolt and double throw 19mm deadbolt for added security. Ideal for use with Pull Handles on exterior doors.



775 SERIES ROLLER BOLT MORTICE LOCK
PART NO. 775

Available finishes:
SC

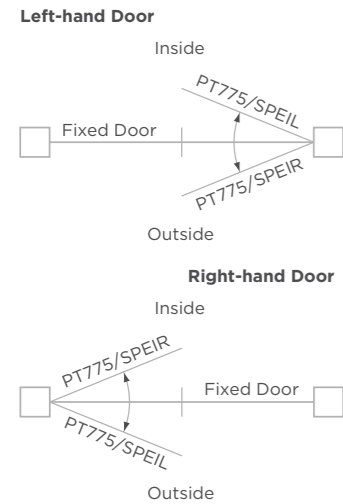

775 EXTENDED STRIKE PLATE
PART NO. PT775/SPEILS

Available finishes:
SS

Featuring a 'ramp' in the cut-out area that receives the roller bolt to facilitate easier opening and closing of pivot doors. For use in conjunction with Mortice Locks on a pivot door.

MORTICE LOCKS & PULL HANDLES

PULL HANDLES



An impressive collection for a statement entry, the Gainsborough 600mm Pull Handles feature 316 Grade Stainless Steel for non compromising durability.



HORIZON
PART NO. 9248PH600

Available finishes:
SS



CURVED
PART NO. 9282PH600

Available finishes:
SS



OBLONG
PART NO. 9266PH600

Available finishes:
SS



STYLED RIGHT-HANDED
PART NO. 9281PHR600

Available finishes:
SS



STYLED LEFT-HANDED
PART NO. 9281PHL600

Available finishes:
SS

Order 2 units for back to back fixing. Styled requires 1 left and 1 right to be ordered.

SECURITY & PATIO DOOR RANGE

**The Gainsborough
Security and Patio Door
Range offers superior
protection for complete
peace of mind.**

Gainsborough's selection of security and patio door hardware meets the needs of today's residential home and renovation markets.

Quick and easy to install, the Gainsborough Security Range of products provide reliability, durability and security.



SECURITY & PATIO DOOR RANGE HINGED DOORS



The ultimate in protection, the Gainsborough Security Range is engineered to keep you safe and secure. The HD7 and Door Closers are specifically designed for hinged screen doors and are available in a variety of finishes.

- Australian design and manufacture
- Interior snib locking feature
- Jemmy resistant deformable strike plate



HD7
PART NO. HD7

Available finishes:
BL / BR / PR / WH

- Australian design and manufacture
- Adjustable closing speed
- Reliable and robust all metal construction
- Fitting tool included for easy installation
- Standard door closer for doors up to 18kgs



DOOR CLOSER
PART NO. DC1

Available finishes:
BL / BR / PR / WH / BP / SL

SECURITY & PATIO DOOR RANGE SLIDING DOORS



For sliding security doors, the Gainsborough SD7 offers reliability, durability and strength to keep you safe and secure. Available in a variety of finishes.

- Australian design and manufacture
- Self-latching lock bolt engages automatically when the door is closed
- Anti-lift pin on catch plate engages the lock body to prevent the sliding door being lifted out of its tracks
- Interior snib locking feature

The Yarra Ridge, for sliding glass patio doors, is designed to meet both your style and security needs.

- Suitable for aluminium, timber and UPVC doors
- Australian design and manufacture
- Self-latching lock bolt engages automatically when the door is closed
- Anti-lift pin on catch plate engages the lock body to prevent the sliding door being lifted out of its tracks
- Interior snib locking feature



SD7
PART NO. SD7

Available finishes:
BL / BR / PR / WH



YARRA RIDGE
PART NO. YR4550

Available finishes:
BL

LEVERSETS & KNOBSETS

The Gainsborough G Series internal sets are the perfect fusion of innovative engineering, eye-catching design and durability.

Complement your external door hardware with our extensive range of G Series internal leversets and knobsets for a uniform look throughout.



G4 LEVERSETS & KNOBSETS
SERIES **G4 LEVERSETS**



The G4 Series of Leversets showcase Gainsborough's most popular styles, available in Bright Chrome and Satin Chrome finishes and featuring a 63mm round rosette. G4 Leversets offer the perfect solution for every home and are available in Passage, Privacy and Dummy functionality.



LIANNA LEVERSET
PART NO. 105LIA

Available finishes:
BC / SC



FIORA LEVERSET
PART NO. 105FIO

Available finishes:
BC / SC



AMELIA LEVERSET
PART NO. 105AME

Available finishes:
BC / SC



CARLA LEVERSET
PART NO. 105CAR

Available finishes:
BC / SC



FLORENCE LEVERSET
PART NO. 105FLO

Available finishes:
BC / SC



BAILEY LEVERSET
PART NO. 105BAI

Available finishes:
BC / SC



OLIVE LEVERSET
PART NO. 105OLI

Available finishes:
BC / SC



AMBASSADOR PASSAGE LEVERSET
PART NO. 500AMB

Available finishes:
BC / SC / PB



TREVI PASSAGE LEVERSET
PART NO. 500TRE

Available finishes:
BC / SC / PB

G4 LEVERSETS & KNOBSETS
SERIES **G4 STAINLESS STEEL LEVERSETS**



The G4 Series also offers levers in 304 Grade Stainless Steel offering stylish durability for the everyday home. Featuring a 63mm diameter round rosette and available in Passage, Privacy and Dummy functionality.



LATORIA LEVERSET
PART NO. S105LAT

Available finishes:
SS



AMARA LEVERSET
PART NO. S105AMA

Available finishes:
SS



KRISTINA LEVERSET
PART NO. S105KRI

Available finishes:
SS



STRAIGHT LEVERSET
PART NO. S105STR

Available finishes:
SS



INCURVE LEVERSET
PART NO. S105INC

Available finishes:
SS

G4 SERIES **Privacy Function for bedrooms and bathrooms.**
This series can be specified as a privacy function - with a privacy button on the inside, panic release from the inside and emergency access from the outside.



G4 SERIES LEVERSETS & KNOBSETS G4 KNOBSETS



Gainsborough's G4 Series internal Knobsets are a reliable and understated choice for your home. Available in Passage, Privacy and Dummy internal functions, as well as an Entrance Lockset function, our range of Knobsets can be used on the majority of doors throughout your home for a consistent look and feel.



GOVERNOR PASSAGE KNOBSET
PART NO. 840GOV

Available finishes:
LB* / PS / SS

*LB for entry only, PB matching passage, privacy and dummy.
Note: Warranty for this product is 5 year tarnish resistant & 10 year mechanical.



TERRACE PASSAGE KNOBSET
PART NO. 500TER

Available finishes:
PB / PS / SS



VILLA PASSAGE KNOBSET
PART NO. 500VIL

Available finishes:
SS

For matching entrance sets please see page 24 and 25.

G3 SERIES LEVERSETS & KNOBSETS G3 LEVERSETS



For an understated look, the G3 Series Leversets offer a modern smaller sized rosette. Featuring 53mm round rosette, the G3 Series is at the forefront of design and interior styling. Available in Passage, Privacy and Dummy functionality.



VENICE LEVERSET
PART NO. 705VEN

Available finishes:
BC / SC



SOFIA LEVERSET
PART NO. 705SOF

Available finishes:
BC / SC



SARINA LEVERSET
PART NO. 705SAR

Available finishes:
BC / SC



MARIJAH LEVERSET
PART NO. 705MAR

Available finishes:
SC



ALYSSIA LEVERSET
PART NO. 705ALS

Available finishes:
BC / SC



ELENA LEVERSET
PART NO. 705ELE

Available finishes:
BC / SC



MAJESTIC LEVERSET
PART NO. 800MAJ

Available finishes:
BC / SC

Note: Warranty for this product is 5 year tarnish resistant & 10 year mechanical.

G3 SERIES Privacy Function for bedrooms and bathrooms.
This series can be specified as a privacy function - with a privacy button on the inside, panic release from the inside and emergency access from the outside.



LEVERSETS & KNOBSETS

G2 TRADITIONAL LEVERSETS



Modern classics, the G2 Traditional Leversets feature a 65mm stepped round rosette and are the perfect complement to any Gainsborough Traditional Trilock. The designer detailing of this range brings a splash of modern sophistication while maintaining traditional elegance for a truly stunning result. Available in Passage, Privacy and Dummy functionality.



SOVEREIGN LEVERSET
PART NO. 1900SOV

Available finishes:
BC / SC



WINDSOR LEVERSET
PART NO. 1900WDR

Available finishes:
BC / SC



OUTLINE LEVERSET
PART NO. 1900OUT

Available finishes:
BC / SC

LEVERSETS & KNOBSETS

G2 CONTEMPORARY LEVERSETS



The G2 Contemporary Leversets combine innovative engineering, modern design and superior quality for the entire home. Featuring a smoothed 65mm round or 68mm square rosette, the G2 Contemporary Leversets can be coordinated with the Gainsborough Contemporary Trilock for a bold design statement. Available in Passage, Privacy and Dummy functionality.



PRECISE LEVERSET
PART NO. 1900PRE

Available finishes:
BC / SC



ALIGN LEVERSET
PART NO. 1900ALI

Available finishes:
BC / SC



ANGULAR LEVERSET
PART NO. 1900ANG

Available finishes:
BC / SC



PRECISE LEVERSET- SQUARE
PART NO. 1800PRE

Available finishes:
BC / SC



ALIGN LEVERSET- SQUARE
PART NO. 1800ALI

Available finishes:
BC / SC



ANGULAR LEVERSET - SQUARE
PART NO. 1800ANG

Available finishes:
BC / SC / MB

G2 SERIES Privacy Function for bedrooms and bathrooms. This series can be specified as a privacy function - with a privacy button on the inside, panic release from the inside and emergency access from the outside.





The G1 premium range provides matching internal lever designs for the Gainsborough Omni and Eclipse Trilock, creating a truly impressive, yet effortless look. Featuring a 55mm round rosette and 316 Grade Stainless Steel, these high quality, technically superior levers provide an inspiring finish. Available in Passage and Dummy functionality. Privacy Adaptors are available.



ALLURE LEVERSET
PART NO. 2900ALL

Available finishes:
SS / PS



ROCHAS LEVERSET
PART NO. 2900ROC

Available finishes:
SS



ENCHANT LEVERSET
PART NO. 2900ENC

Available finishes:
SS



For an even more contemporary look, the G1 range offers Leversets with 57mm square rosettes in 316 Grade Stainless Steel. Available in Passage and Dummy functionality with Privacy Adaptors also available.



ENCHANT LEVERSET- SQUARE
PART NO. 2800ROC

Available finishes:
SS



ROCHAS LEVERSET- SQUARE
PART NO. 2800ENC

Available finishes:
SS



ALLURE LEVERSET- SQUARE
PART NO. 2800ALL

Available finishes:
SS / PS

CLASSIC SERIES

The Gainsborough Classic Series showcases elegance and charm creating timeless style solutions.

Made from aluminium, the Classic Series Knobs and Leversets harmonise perfectly with traditionally designed homes.



CLASSIC SERIES CLASSIC KNOBS



The Gainsborough range of traditional knobs is designed for general interior doors. For privacy locking on Gainsborough Classic Knobs, just add a 309 Privacy Adaptor to a passage set.



WARM WHITE DOOR KNOB
PART NO. 1305WAW

Available finishes:
BG / BC / SC (backplate finish)



WARM WHITE WARDROBE KNOB
PART NO. 1356WAW

Available finishes:
BG / BC / SC (backplate finish)



WARM WHITE CUPBOARD KNOB
PART NO. 1366WAW

Available finishes:
BG / BC / SC (backplate finish)



WHITE DOOR KNOB
PART NO. 1305WHI

Available finishes:
BG / BC / SC (backplate finish)



WHITE WARDROBE KNOB
PART NO. 1356WHI

Available finishes:
BG / BC / SC (backplate finish)



WHITE CUPBOARD KNOB
PART NO. 1366WHI

Available finishes:
BG / BC / SC (backplate finish)

CLASSIC SERIES CLASSIC LEVERSETS



An impressive collection of classically styled leversets to complement traditionally designed homes. Lever designs available in Passage, Privacy and Dummy functionality.



ROYALE LEVER
PART NO. 600ROY

Available finishes:
BC / BG / SC



IMPERIAL LEVER
PART NO. 600IMP

Available finishes:
BC / SC



WINDSOR LEVER
PART NO. 600WDR

Available finishes:
BC / SC

Privacy Function for bedrooms and bathrooms.

This series can be specified as a privacy function - with a privacy button on the inside, panic release from the inside and emergency access from the outside.



SLIDING CAVITY DOOR SETS

For interior sliding doors, Gainsborough's range of cavity door sets will leave a lasting impression in both function and design.

Offered in Passage, Privacy and Connecting sets, the range suits a variety of door applications.



SLIDING CAVITY DOOR SETS SQUARE, RECTANGULAR & CIRCULAR



Available in Passage, Privacy and Connecting functions, the cavity door sets suit a 54mm diameter hole on doors 32mm - 45mm thick. The Privacy and Connecting lock also feature a hinged pull-tab on the faceplate which can be raised to pull door closed from within cavity.



394 PASSAGE SLIDING CAVITY SET - RECTANGULAR

Available finishes:
BC / SC



386 PASSAGE SLIDING CAVITY SET - SQUARE

Available finishes:
BC / SC / MB



396 PASSAGE SLIDING CAVITY SET - CIRCULAR

Available finishes:
BC / SC / PB

SLIDING CAVITY DOOR SETS FLUSH PULLS



The Gainsborough range of stylish flush pulls are designed to complement any sliding door in a variety of finishes.



RADIUS FLUSH PULL
PART NO. 390

Available finishes:
BC / BG / SC



RING FLUSH PULL
PART NO. 6600

Available finishes:
BC / SC



RECTANGULAR FLUSH PULL
PART NO. 392

Available finishes:
BC / BG / SC

AUXILIARY HARDWARE

Gainsborough provides a wide range of accessories to offer the complete solution for any new or renovated home.

Complementing Gainsborough's comprehensive range of door hardware, this range provides the finishing touch across an extensive range of applications.



AUXILIARY HARDWARE LATCHES



Gainsborough's 480 series tubular latches are dual sprung to allow firm action during normal operation of door knobs and levers ensuring soft door closure. The self-aligning cam allows for easy installation when used with Gainsborough door hardware. Choose from rectangular, radius corner and drive-in latch varieties. Available in both 60mm or 70mm (Rectangular and Drive-In only) backset options.



RADIUS FACE
PART NO. 488 60mm latch

Available finishes:
BC / **PB** / SC



RECTANGULAR FACE WITH UNIVERSAL STRIKE
PART NO. 480T 60mm latch

Available finishes:
BC / PB / **SC**



DRIVE-IN COLLAR
PART NO. 482 60mm latch / 483 70mm latch

Available finishes:
BC / PB



REACTANGULAR FACE WITH STRIKE
PART NO. 480 60mm latch / 481 70mm latch

Available finishes:
BC / SC / PB

AUXILIARY HARDWARE DOOR CLOSERS



Gainsborough door closers are suitable for timber or metal door installation, and incorporate adjustable arm and parallel arm bracket, independent latching and closing speed adjustment valves.



HYDRAULIC DOOR CLOSER
PART NO. 3002V / 3003V

Available finishes:
SL
—
3002V suits 25-45kg doors and 3003V suits 40-65kg doors.



3101 HYDRAULIC DOOR CLOSER
PART NO. 3101

Available finishes:
SL



3003ABC HYDRAULIC DOOR CLOSER
PART NO. 3003ABC

Available finishes:
SL

AUXILIARY HARDWARE



WALL STOP
PART NO. 6207

Available finishes:
BC / SC

75mm length with rubber buffer, tube diameter 19mm.



WALL STOP
PART NO. 6203

Available finishes:
BC / SC

75mm length with rubber buffer.



FLOOR STOP
PART NO. 6205

Available finishes:
BC / SC

45mm diameter base, 23mm height.

AUXILIARY HARDWARE



SPACER RINGS - SET OF 2
PART NO. KT700SR

Available finishes:
BC / SC



REBATE KIT
PART NO. KT800REB

Available finishes:
BC / PB / SC

Suits 480, 800 Series.

Also available:
KT 850REB (BC, PB, SC) for 850, 845, 550 & 545 Deadbolts and KT 890 REB (BC, PB, SC) for Trilocks.



DOOR SECURITY BOLT
PART NO. 444

Available finishes:
BC / PB / SC

Star Key also available separately.



FLUSH BOLTS
PART NO. 6051 / 6052

Available finishes:
BC / SC

6051 = 150mm x 19mm
6052 = 200mm x 19mm



MAGNETIC CATCH
PART NO. MC22

Available finishes:
BC

Ideal for wardrobe and cupboard doors.



AUXILIARY PRIVACY SET
PART NO. 70PS

Available finishes:
BC / SC



DUMMY FIXING KIT
PART NO. PT 700/DFP

Kit for Wood Screw Fixing.
For use on non-operational dummy doors, i.e. the fixed side of an internal double door. Purchase two dummy fixing kits to convert a G3 or G4 Series Leverset into two dummy levers.



DUMMY FIXING KIT
PART NO. KT 700A DFP

Kit for Through Fixing.
Purchase two dummy fixing kits to convert a G3 or G4 Leverset into two dummy levers. Wood screws are also provided for an alternative fixing option.



INSTALLATION KIT
PART NO. PT800/IK

Includes 54mm hole saw, mandrel and 25mm spade bit.

AUXILIARY HARDWARE DOOR SEALS & WEATHERSTRIPS

Providing protection all year around, our Door Seals & Weatherstrips range protects against draughts, cold, heat, dust, insects and noise, while saving on heating and cooling costs. Gainsborough offers a wide selection of quality Door Seals & Weatherstrips to cater for a variety of applications.



ROLLING
PART NO. GS1

GS1 is recommended for interior doors and suits hinged, inward opening, single or double doors, helping to protect against draughts, cold, heat and dust. The GS1 rolling seal features rollers for smooth action and comes with easy to fit fixing brackets for simple installation.

Available finishes:
GR



AUTOMATIC
PART NO. GS3

GS3 is recommended for external doors and suits hinged, inward opening single doors, helping to protect against draughts, cold, heat, dust and insects. The GS3 automatically lifts as the door is opened to clear carpet and seals on door closure. Features aluminium construction and durable rubber.

Available finishes:
GD / **BZ** / SL



BRUSH
PART NO. GS2

GS2 is recommended for interior and exterior doors and suits hinged, inward or outward opening, single or double doors, helping to protect against draughts, cold, heat, dust and insects. The GS2 brush seal also suits sliding doors and security/screen doors and features a hard wearing polypropylene brush.

Available finishes:
GD / BZ / **SL**



STORM
PART NO. GS4

GS4 is recommended for exterior doors and suits hinged, inward or outward opening, single or double doors, helping to protect against draughts, cold, heat, dust, noise, rain and insects. The GS4 storm proof seal features a two piece aluminium construction and durable rubber for tight sealing.

Available finishes:
GD / **BZ** / SL (915mm length only)
GD (825mm and 1750mm length only)
ML

AUXILIARY HARDWARE DOOR SEALS & WEATHERSTRIPS

The Door Seal range includes a selection of products designed for either exterior or interior door applications or both. Choose from Rolling, Brush, Automatic, Storm and Rubber door seal versions. The Gainsborough Weatherstrip range is ideal for surrounding doors and windows and includes Foam, Rubber and Pile varieties.



RUBBER
PART NO. GS5

GS5 is recommended for interior and exterior doors and suits hinged, inward or outward opening, single or double doors, helping to protect against draughts, cold, heat, dust and insects. The GS5 seal is ideal for hinged security/screen doors and features aluminium construction and durable rubber.

Available finishes:
GD / BZ / SL



FOAM
PART NO. GS20

GS20 Foam suits hinged doors and windows and helps protect against draughts, cold, heat, dust, noise and insects.

Available finishes:
WH / **BR**



PILE
PART NO. GS40

GS40 Pile suits hinged doors and sliding doors and helps protect against draughts, cold, heat, dust and insects.

Available finishes:
BR

RUBBER
PART NO. GS30 & GS31

GS30 ("P" profile) and GS31 ("E" profile) Rubber suits hinged doors and windows and helps protect against draughts, cold, heat, dust, noise, rain, insects and rodents. Ozone and UV light resistant.

Available finishes:
WH / **BR**

MATT BLACK RANGE

Be bold. Enter with style.

At the forefront of style and innovation, Gainsborough's Matt Black range provides a blend of contemporary and chic; perfect for homes looking to showcase the latest trends.



MATT BLACK RANGE



The Matt Black Trilock highlights contemporary design at its best, providing a sleek, modern finish. Featuring a 68mm square rosette, the Matt Black Leversets coordinate perfectly with the Gainsborough Matt Black Trilock for a bold design statement. Available in Passage, Privacy and Dummy functionality.



TRILOCK CONTEMPORARY ANGULAR LEVERSET SINGLE CYLINDER
PART NO. 8401ANGMB

Available finishes:
BC / **MB** / SC



TRILOCK CONTEMPORARY ANGULAR LEVERSET DOUBLE CYLINDER
PART NO. 8901ANGMB

Available finishes:
BC / **MB** / SC



ANGULAR PASSAGE LEVERSET
PART NO. 1805ANGMB

Available finishes:
BC / **MB** / SC



ANGULAR PRIVACY LEVERSET
PART NO. 1815ANGMB

Available finishes:
BC / **MB** / SC

MATT BLACK RANGE



Complete the contemporary Matt Black look throughout your home with the impressive 600mm Oblong Pull Handle, the reliable Square Deadbolt and the Sliding Cavity Door Sets.



SQUARE DEADBOLT
PART NO. 1851SMMB

Available finishes:
BC / **MB** / SC



CAVITY SETS - PASSAGE
PART NO. 386MBS

Available finishes:
BC / **MB** / SC



OBLONG 600MM PULL HANDLE
PART NO. 9266PH600MB

Available finishes:
MB / SS



EURO CYLINDER ESCUTCHEON
PART NO. Z5SEEUMB

Available finishes:
CP / **MB** / SC



CAVITY SETS - PRIVACY
PART NO. 385MBS

Available finishes:
BC / **MB** / SC



Complete the look with Gainsborough Hardware.

GAINSBOROUGH HANDING AND INFORMATION



VISIT US ONLINE
gainsboroughhardware.com.au



Handing

Some of our door furniture products are handed. To assist you with identifying the required handing, please refer to this simple diagram for an explanation.

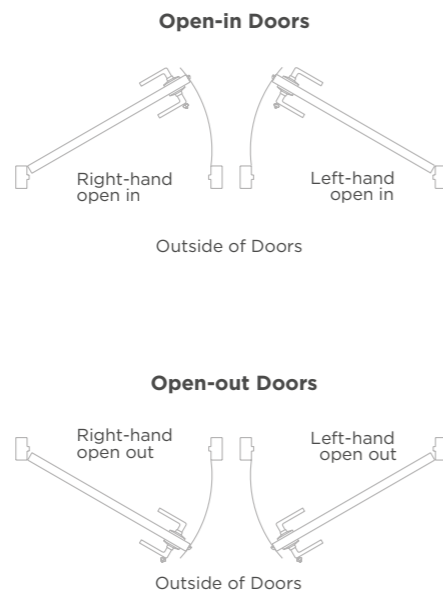

General Information

Safety Notice: For Double Cylinder function, we recommend that you do not keylock from the inside of the door when occupants are inside. If you choose to do so, ensure key is readily accessible and operable by all persons who may need to exit the building in an emergency.

Ensure occupants know how to operate lock and keys to gain immediate exit.

Life is for living and Gainsborough is designed that way. Our products are created with you in mind, giving you greater access to enter your world, securely and effortlessly.

Style is more than just looks, it's about the way you live and move and work.

That's why Gainsborough is more than just a fashion statement. Beyond form and finish, our products are designed for you to live your lives the way you want, every time.

Gainsborough
ENTER WITH STYLE



Gainsborough Hardware Industries Limited

A.B.N. 25 004 792 269

Head Office: 31-33 Alfred St,
Blackburn, Victoria 3130
PO Box 330, Blackburn, Victoria 3130

Tel: +61 3 9877 1555

Admin & Export Fax: +61 3 9894 1599

E-mail: ghisales@gwagroup.com.au

Sales Hotline: 13 14 18

Sales Fax Hotline: 13 18 14

Gainsborough
ENTER WITH STYLE™

Printed February 2017

www.gainsboroughhardware.com.au

Due to continuous product development, some products may vary from that shown. The Gainsborough limited guarantee, shown on the pages within, applies only when properly installed and subjected to no more than fair wear and tear. This guarantee does not extend to labour costs, personal loss, death or injury, or economic, consequential or property damage of any kind whatsoever. Due to the nature of the printing process, colours may vary from those shown in this brochure.