



ZANDA
ARCHITECTURAL HARDWARE



More than quality
- an experience



Seamlessly blending style with quality, these products are at the forefront in architectural finesse and form and are only available from...



Zanda Architectural Hardware is pleased to present in this catalogue an unparalleled selection of genuine, superior, quality door furniture and accessories especially chosen to compliment the high standard of architecture found in today's homes and buildings.

Zanda is a family owned Australian company with the experience and expertise essential for providing the efficient and courteous service that attracts and retains satisfied customers. Today the Zanda name has developed a strong sense of corporate identity and become renown for its commitment to continuous improvement.

We invite you to peruse the range, make your choice and compare the difference.

Our Vision

- To become a household name by providing exhilarating service, high quality products, products that never were and a compelling alternative in order to develop long term partnerships that create prosperity and fulfilment for all.
- To enable, ennoble and enrich everyone in our organisation, and to enrich others by contributing towards charitable causes and humanitarian needs.

Our Mission

To become the 'go-to' company for independent resellers, architects, interior designers, builders and end users by providing:

- High quality architectural hardware along with unique designs and exhilarating service.
- A compelling alternative to the independent reseller which enables them to compete with the big box stores.

Corporate Culture

The determination to go beyond what our customers would ever expect by offering amazing service, unique designs and superb quality so that every person and organisation we deal with says 'wow'.

CONTENTS

7-30

Entrance Pull Handles

- 7 Entrance Pull Handles
- 25 Push/Pull Plates
- 26 Pull Handle Lock Kits

31-62

Door Furniture

- 31 Visca
- 39 Astron
- 53 Futura
- 57 Triad
- 59 Jura & Jura Elite

63-68

Sliding Door Hardware

- 64 Flush Pulls
- 64 Edge Pulls
- 64 Flush Rings
- 65 Flush Pull Kits
- 67 Verve Range
- 68 Cavity Suite
- 68 Italian Range

69-80

Door Accessories

- 70 Door Stops
- 71 Door Holders
- 73 Hinges
- 74 Bolts
- 77 Wardrobe Accessories
- 78 Escutcheons
- 78 Knockers
- 79 Privacy Hardware
- 80 Hooks
- 80 Bannister Brackets
- 80 Door Viewer

81-98

Door Controls

- 83 Contract Closer
- 85 Architectural Closers
- 90 Extreme Closer
- 91 Cam Action Closer
- 93 Concealed Cam Action Closer
- 95 Floor Springs
- 96 Transom Closers
- 97 Pivots & Stops
- 98 Genie Closers

99-100

Letterbox Hardware

- 100 Numerals & Alphabets
- 100 Letterboxes

101-116

Cabinet Handles

- 102 Designer Handles
- 113 Designer Handles Aluminium
- 114 Designer Knobs
- 115 Economy Handles
- 116 Extrusions

117-128

Locks, Latches, Cylinders

- 118 Latches & Safety Latches
- 119 Privacy Bolts
- 119 Roller Catches
- 121 Stealth Electronic Deadbolt
- 122 Roller Mortice Locks
- 123 Nightlatches
- 125 Euro Profile Motice Locks
- 126 Mortice Deadbolts
- 126 Sliding Door Mortice Locks
- 127 Rebate Kits, Extended Strike Plates
- 128 Euro Profile Cylinders

129

Finishes, Care & Maintenance

130-131

Our Services

132-133

Displays & Merchandising

134

Technical

135

Index





7 Bellows St, Welshpool
Western Australia 6106

PO Box 713, Bentley
Western Australia 6982

Telephone: (08) 9458 4966
Facsimile: (08) 9458 4967
Email: sales@zanda.com.au

www.zanda.com.au

Dear Reader,

What do you get when you deal with Zanda?

Every purchase is based on trust. Trust that you will receive good quality, good service and good value.

We respect that trust and it is our commitment to never let you down.

That is why we have such a strong and compelling reason to go beyond what our customers would ever expect by offering amazing service, unique designs and superb quality. As the owner, it is my responsibility to ensure that every person and organisation with whom we deal is uplifted by the experience.

We come from a long history of serving customers. Our parent company was founded in 1927. You don't get to keep a family company for nearly 90 years by being indifferent to the customer.

We give you our word, that should you trust us with your valuable custom, we will stand behind our commitment to ensure that you truly will say "wow".

Very Best Regards

A handwritten signature in black ink, appearing to read "Bill Wallis", written over a thin, curved line.

Bill Wallis

Founder & Managing Director

PS: Please call any time on—1300 ZANDA1

A NUMBERS GAME



800,000+
ways of expressing yourself
with Zanda hardware



2
hours for dispatch of orders

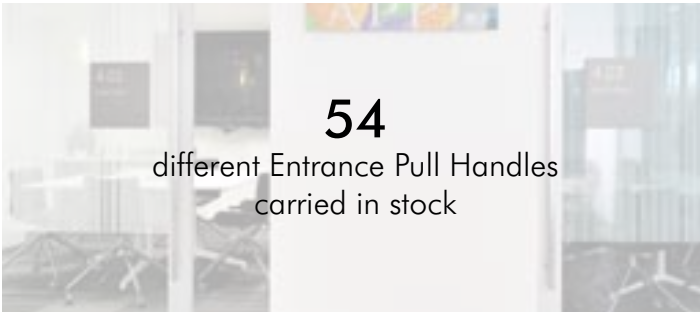

54
different Entrance Pull Handles
carried in stock



2516
product lines carried
in stock as at June 2015



19
people on average hand-crafted each
piece of Zanda hardware

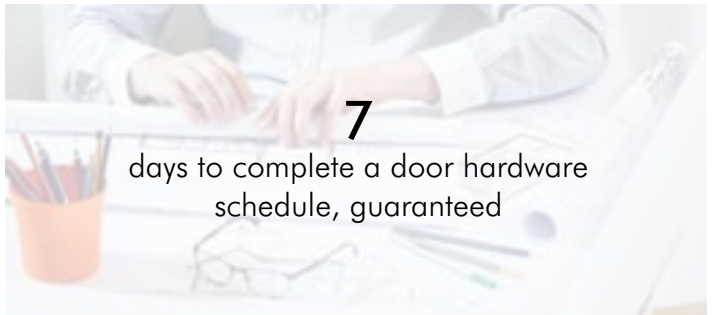

7
days to complete a door hardware
schedule, guaranteed

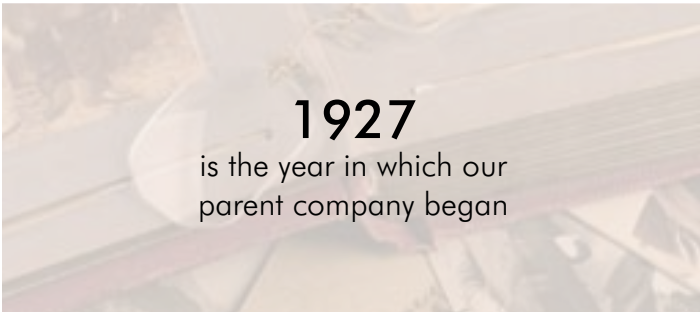

1927
is the year in which our
parent company began

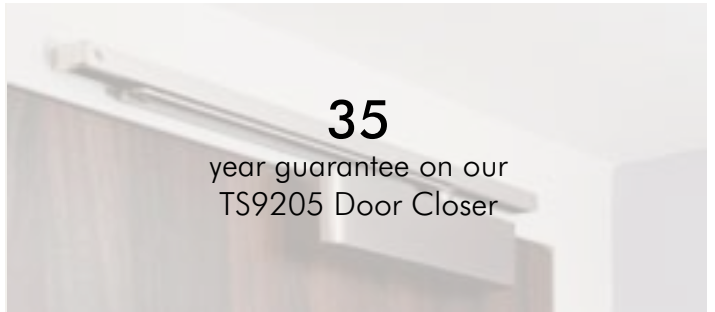

35
year guarantee on our
TS9205 Door Closer



0
competitors have ever consistently matched Zanda's superior level of customer service



ZANDA
ARCHITECTURAL HARDWARE

WHICH ONE ARE YOU? - CHECK OUT YOUR BENEFITS!



An Owner?

- **Absolute peace of mind** - unsurpassed quality, the minimum warranty is 10 years through to high end products with an amazing lifetime warranty!
- **Exhilarating designs** - find your exact taste amongst hundreds of the finest products in this catalogue.
- **The very best professional advice** - deal with the very best and most passionate, handpicked resellers who specialise in door hardware and who only sell the best.

A Reseller?

- **Unparalleled service** - we dispatch within two hours of receiving the order!
- **Easy communication** - someone will answer the phone within eight seconds and...it's a real live person!
- **Exclusive to you** - we don't sell to the big box stores! Protect your margin, your image and your name by selling a renowned product that can only be purchased through you.
- **Superior products** in terms of quality, designs and range.
- **Unique styles** that differ from the tired and stale brands
- **Superior packaging & point of sale material** that lifts your store and helps market the product and boost your sales.



An Architect or Interior Designer?

- **Unique styles** - at last a breath of fresh air with unique products that suit all architectural styles
- **Form and function epitomised** in a range that encompasses everything from Classical to Sublime and from Art Deco to Modern and everything in between.
- **Free scheduling** - we guarantee we'll complete a comprehensive door hardware schedule in seven days.
- **Free samples** - where applicable Zanda can provide samples to assist in your selection process.
- **Ease of communication** - ring for advice on placement, styles, technical information or pricing.



A Builder?

- **Save money** - save money with the fastest and easiest to fit door furniture on the market and a price point for every client.
- **Save time** - never get held up on site again. We dispatch within two hours of receiving the order!
- **Boost sales** - with the best quality and range and an exclusive brand, you will never look back.
- **Add class** - If all of the above is not enough, add one of our awesome displays (see page 133) to your display room to add some zing to your samples and give your clients the ultimate choice.



ENTRANCE PULL HANDLES



- 8 Details & Information
- 9 V23, Glyde & Aquila
- 11 Omega
- 13 Round Profile
- 15 Square Profile
- 17 Polo
- 18 Square Profile Offset
- 19 Round Profile Offset
- 21 Nitro
- 23 Torch
- 24 Bow & Arco
- 25 Push/Pull Plates & Special Order
- 26 Pull Handle Lock Kits
- 30 Pull Handle & Lock Kit Combinations

First impressions count. That's why more architects and designers are specifying Zanda Pull Handles in some of Australia's finest buildings. Appearance, durability, versatility, ease and flexibility of installation are just some of the qualities that have transformed our Pull Handles into an industry mainstay.

Our unique range comprises of 17 different styles and 52 different sizes ranging from 300mm right up to 1800mm in length.

What's more, all of Zanda's Pull Handles are constructed from 316 Marine Grade Stainless Steel making them ideally suited to corrosive applications or high humidity situations.



Entrance Pull Handles > Details & Information

Fixing Options

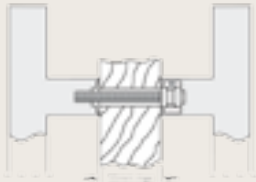

Back to Back (BB)
Suitable for Timber, Aluminium & Glass Doors



Face Fix (FF)
Suitable for Timber Doors



Rear Fix (RF)
Suitable for Timber, Aluminium Doors



Glass Rear Fix (GRF)
Suitable for Glass Doors

Rear Fixing Bolts

For Timber & Aluminium Doors - 60mm Length



M8: 7312
M6: 7340

For Glass Doors - 30mm Length



M8: 7304
M6: 7305

Finish: Stainless Steel

How to order:

(Code)(Fixing)(Finish)

For example:
Polo 600mm, Back to Back, Stainless Steel
7100 BB SS

↑
Code

↑
Fixing:
BB (Back to Back)
FF (Face Fix)
RF (Rear Fix)
GRF (Glass Rear Fix)

↑
Finish:
SS
P/SS
ACR

Dimensions

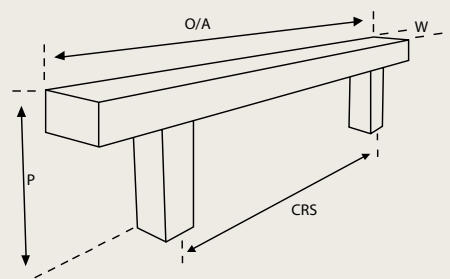

CRS: Screw/Bolt Centres, O/A: Overall Length
W: Width (maximum), P: Projection (Maximum)

Passage, Privacy & Lockset options when using Zanda Entrance Pull Handles:

For Passage Set Options, we recommend:

1195 - Heavy Duty Roller Catch 1180 - Door Magnets



See page 119 for details on these products

For Stealth Electronic Lock see page 26



For Pull Handle Lock Kits see page 28 & 29



For Roller Lock Kits see page 27



For Privacy Options, see page 79

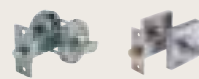

These 316 Grade Stainless Handles are within reach of even the smallest of budgets. Style and economy at its best.

9



Entrance Pull Handles > 316 Stainless Steel Commercial

See Page 129 for Care and Maintenance

NEW

Glyde

V23

Aquila

Marine Grade 316 SS



Code	CRS	O/A	W	P
7183*	575mm	600mm	25mm	60mm

Finish: SS, PC *Compliant with AS1428

Marine Grade 316 SS



Code	CRS	O/A	W	P
7306	450mm	482mm	32mm	85mm
7307	600mm	632mm	32mm	85mm
7308	900mm	932mm	32mm	85mm

Finish: SS, PC

Marine Grade 316 SS



Code	CRS	O/A	W	P
7309	300mm	332mm	32mm	80mm
7310	450mm	482mm	32mm	80mm

Finish: SS, PC



Sold as back to back pairs but also available as singles with face fix or rear through door fixing.

See Page 26-29 for Lock options.

10

ZANDA
ARCHITECTURAL HARDWARE



Entrance Pull Handles > 316 Stainless Steel

See Page 129 for Care and Maintenance

Omega

NEW

7300

7301

7302

7303

Marine Grade 316 SS

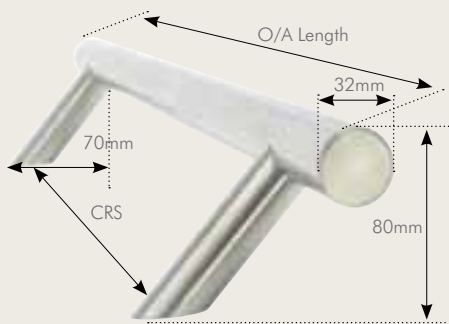

Code	CRS	O/A	W	P
7300	400mm	600mm	32mm	80mm
7301	700mm	900mm	32mm	80mm
7302	1000mm	1200mm	32mm	80mm
7303	1600mm	1800mm	32mm	80mm
	+ midpoint			

Finishes: SS, PSS, PC

Sold as back to back pairs but also available as singles with face fix or rear through door fixing.

See Page 26-29 for Lock options.

12

ZANDA
ARCHITECTURAL HARDWARE



Entrance Pull Handles > 316 Stainless Steel

See Page 129 for Care and Maintenance

Round Profile

7063

7025

7026

7092

7093

7094

Marine Grade 316 SS



Code	CRS	O/A	W	P
7063*	200mm	300mm	19mm	60mm
7025*	250mm	450mm	32mm	76mm
7026*	400mm	600mm	32mm	76mm
7092*	700mm	900mm	32mm	76mm
7093*	1000mm	1200mm	32mm	76mm
7094*	1600mm	1800mm	32mm	76mm

Finishes: SS, PC

*Compliant with AS1428

Sold as back to back pairs but also available as singles with face fix or rear through door fixing.

See Page 26-29 for Lock options.

14

ZANDA
ARCHITECTURAL HARDWARE



Entrance Pull Handles > 316 Stainless Steel

See Page 129 for Care and Maintenance

Square Profile

7066

7054

7055

7095

7096

7097

Marine Grade 316 SS



Code	CRS	O/A	W	P
7066	200mm	300mm	20x20mm	50mm
7054*	276mm	450mm	25x25mm	68mm
7055*	426mm	600mm	25x25mm	68mm
7095*	726mm	900mm	25x25mm	68mm
7096*	1026mm	1200mm	25x25mm	68mm
7097*	1626mm	1800mm	25x25mm	68mm

Finishes: SS, PC

*Compliant with AS1428

Sold as back to back pairs but also available as singles with face fix or rear through door fixing.

See Page 26-29 for Lock options.

16

ZANDA
ARCHITECTURAL HARDWARE



Add style and flair to your entry point.

Entrance Pull Handles > 316 Stainless Steel

See Page 129 for Care and Maintenance

Polo

NEW 1800mm

7098

7099

7100

7101

7102

Marine Grade 316 SS



Radiused corners for improved ergonomics

Code	CRS	O/A	W	P
7098*	270mm	300mm	30x15mm	50mm
7099*	410mm	450mm	40x20mm	60mm
7100*	560mm	600mm	40x20mm	60mm
7101*	860mm	900mm	40x20mm	60mm
7102*	1760mm	1800mm	40x20mm	60mm

Finishes: SS, PSS, BLK, PC

*Compliant with AS1428

Sold as back to back pairs but also available as singles with face fix or rear through door fixing.

See Page 26-29 for Lock options.

Entrance Pull Handles > 316 Stainless Steel

See Page 129 for Care and Maintenance

Square Profile Offset

7064

7065

Marine Grade 316 SS

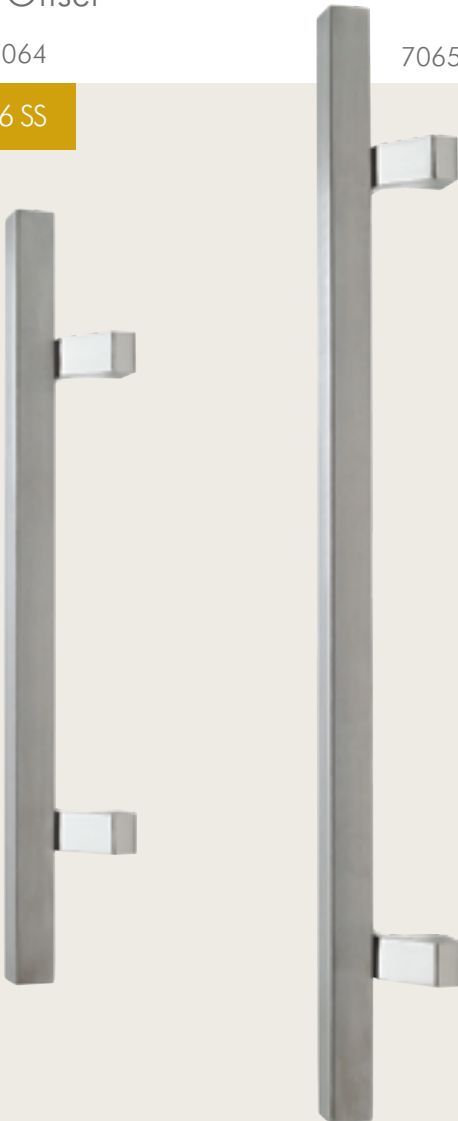

Available in 1200 & 1800mm lengths on special order

Code	CRS	O/A	W	P	Offset
7064	276mm	450mm	25x25mm	72mm	39mm
7065	426mm	600mm	25x25mm	72mm	39mm
7145	726mm	900mm	25x25mm	72mm	39mm

Finishes: SS, PC

Sold as back to back pairs but also available as singles with face fix and rear through door fixing available (see page 8 for details). See Page 26-29 for Lock options.



NEW

Entrance Pull Handles > 316 Stainless Steel

See Page 129 for Care and Maintenance

Round Profile Offset

7027

7028

Marine Grade 316 SS



Code	CRS	O/A	W	P	Offset
7027*	250mm	450mm	32mm	75mm	35mm
7028*	400mm	600mm	32mm	75mm	35mm
7142*	700mm	900mm	32mm	75mm	35mm
7143*	1000mm	1200mm	32mm	75mm	35mm
7144*	1600mm + midpoint	1800mm	32mm	75mm	35mm

Finishes: SS, PC

*Compliant with AS1428

Sold as back to back pairs but also available as singles with face fix and rear through door fixing available (see page 8 for details). See Page 26-29 for Lock options.

NEW

22

ZANDA
ARCHITECTURAL HARDWARE



Entrance Pull Handles > 316 Stainless Steel

See Page 129 for Care and Maintenance

Nitro

NEW

7128

7129

7130

7131



Radiused corners for improved ergonomics

Code	CRS	O/A	W	P	Offset
7128	280mm	300mm	20x20mm	50mm	30mm
7129*	425mm	450mm	25x25mm	60mm	35mm
7130*	575mm	600mm	25x25mm	60mm	35mm
7131*	875mm	900mm	25x25mm	60mm	35mm

Finishes: SS, PC

*Compliant with AS1428

Sold as back to back pairs but also available as singles with face fix or rear through door fixing.

See Page 26-29 for Lock options.

22

ZANDA
ARCHITECTURAL HARDWARE



Entrance Pull Handles > 316 Stainless Steel

See Page 129 for Care and Maintenance

Torch

NEW

7103SS

7103P/SS

7103BLK

7104SS

7104P/SS

7104BLK

13500ACR

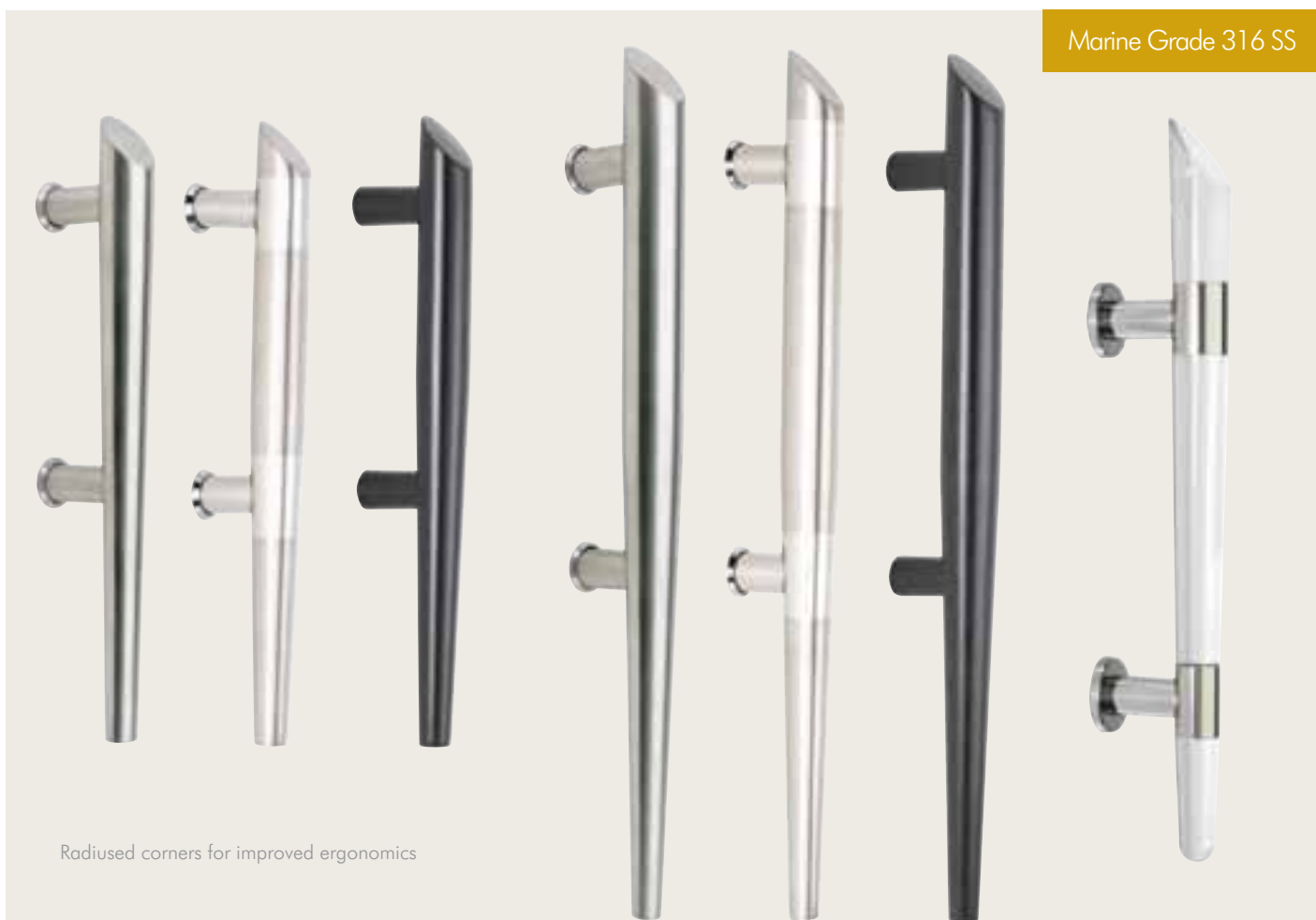

Marine Grade 316 SS

Radiused corners for improved ergonomics

Code	CRS	O/A	W	P	Finish
7103SS*	160mm	350mm	32mm	75mm	Stainless Steel
7103P/SS*	160mm	350mm	32mm	75mm	Two-toned (Polished/Stainless Steel)
7103BLK*	160mm	350mm	32mm	75mm	Matt Black
7104SS*	250mm	530mm	38mm	80mm	Stainless Steel
7104P/SS*	250mm	530mm	38mm	80mm	Two-toned (Polished/Stainless Steel)
7104BLK*	250mm	530mm	38mm	80mm	Matt Black
13500ACR*	210mm	420mm	36mm	78mm	Acrylic

*Compliant with AS1428

Sold as back to back pairs but also available as singles with face fix or rear through door fixing.

See Page 26-29 for Lock options.

Entrance Pull Handles > 316 Stainless Steel

See Page 129 for Care and Maintenance

Bow

7069

7070

Marine Grade 316 SS

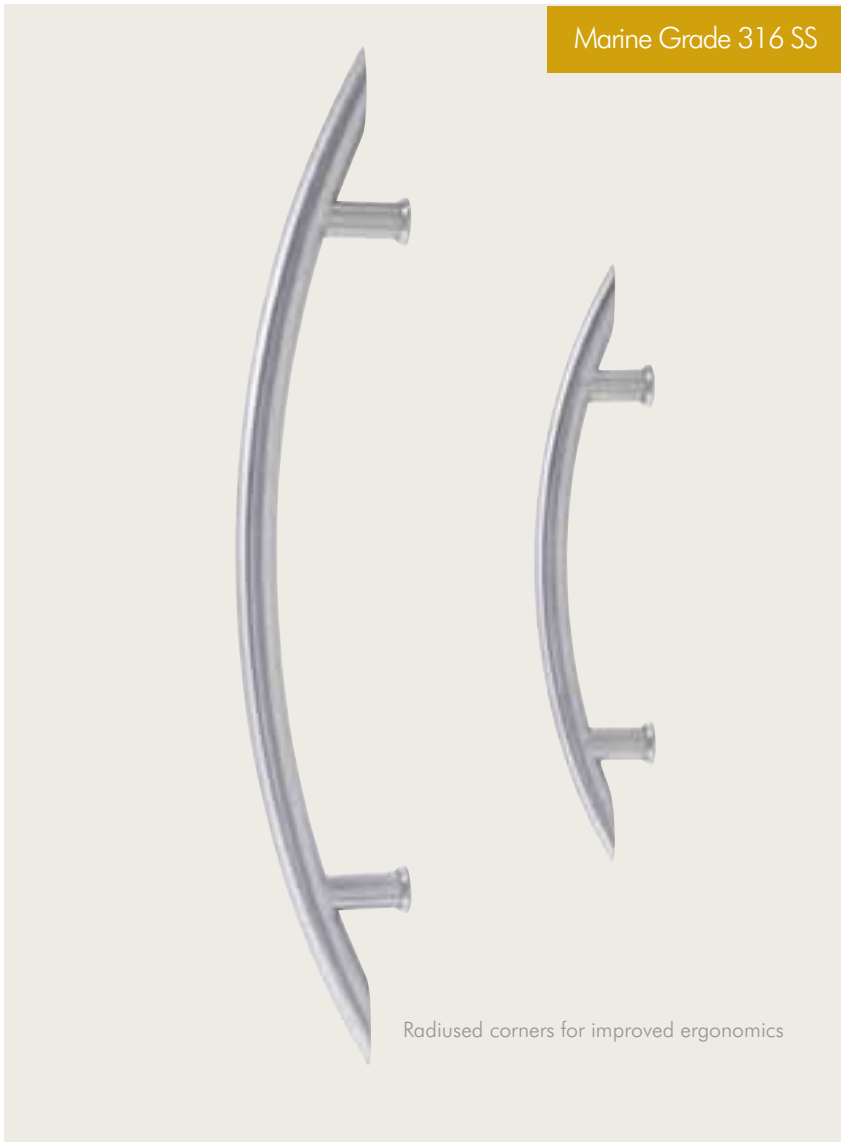

Radiused corners for improved ergonomics

Code	CRS	O/A	W	P
7070	200mm	340mm	19mm	65mm
7069	400mm	610mm	25mm	95mm

Finishes: SS, PC

Arco

Marine Grade 316 SS

NEW



Code	CRS	O/A	W	P
13501*	300mm	600mm	32mm	72mm

Finishes: P/SS (Two-toned), PC ***Compliant with AS1428**

Sold as back to back pairs but also available as singles with face fix or rear through door fixing.

See Page 26-29 for Lock options.

Entrance Pull Handles > Push/Pull Plates & Special Order

See Page 129 for Care and Maintenance

Pull Handle On Plate

Custom Made Pull Handles



7165
300 x 65mm Plate
16 x 250mm D Pull



Finish: SS, PC



Dream it, and we'll make it. MOQs and lead times may apply

Push Plate

7166
300 x 65mm
Plate

7166.E
Engraved with PUSH
300 x 65mm
Plate



Finish: SS, PC

Powdercoating Option

Your Entrance Handles can be any colour you want

You'll get the following benefits with Powdercoat finished Pull Handles:

- Corrosion resistance, improve the longevity of your hardware
- Make a point of difference to your home
- Coordinate with your Aluminium Joinery

Just add 35% to our stainless steel pricing, and we'll powdercoat our Pull Handles to any standard Dulux colour.

Contact us for a full list of available colours.



Never before has electronic convenience of this quality been available at such value.

Entrance Pull Handles > Pull Handle Lock Kits

STEALTH
ULTIMATE CONVENIENCE
ELECTRONIC DEADBOLT LOCK

NEW

Stealth Electronic Deadbolt Lock

1317

Three easy ways to open









- » High security deadbolt with anti-saw protection
- » Easily retrofits over standard deadbolt holes
- » Multiple codes including temporary codes can be programmed
- » Common C4 key profile for easy rekeying to the rest of your house
- » Easy DIY installation, instructions included
- » Can be used in conjunction with Pull Handles or Lever Handles
- » Modern Brushed Nickel finish

Pin Code

Remote

Key

Pull Handle & Stealth Electronic Deadbolt Combo Kits

Omega	Round	Nitro	Square	Polo	Glyde
1257 400mm crs, 600mm o/a	1252 400mm crs, 600mm o/a	1254 575mm crs, 600mm o/a	1256 426mm crs, 600mm o/a	1253 560mm crs, 600mm o/a	1255 575mm crs, 600mm o/a
					

All kits include: 600mm Back to Back Pull Handle, 1317 Stealth Lock, 1195 Roller Catch & 5264 Door Stop

Entrance Pull Handles > Pull Handle Lock Kits

Roller Lock Kits

1157 Pictured



Square Roller Lock Kits:
1157-1 Includes Key/Key Cylinder
1157-2 Includes Key/Turn Cylinder

Round Roller Lock Kits:
1149 Includes Key/Key Cylinder
1150 Includes Key/Turn Cylinder

Finishes: BN, SC, BLK & PC

Roller Bolt operated by push or pull from either side (no lever handle required).
Deadbolt easily activated when required.
Roller Strength adjustable.

All lock kits include 1140 Roller Lock (see page 122 for details), Escutcheon (Round or Square) and 70mm cylinder Double (Key/Key) or Single (Key/Turn)

1150 Pictured with Round Pull Handle

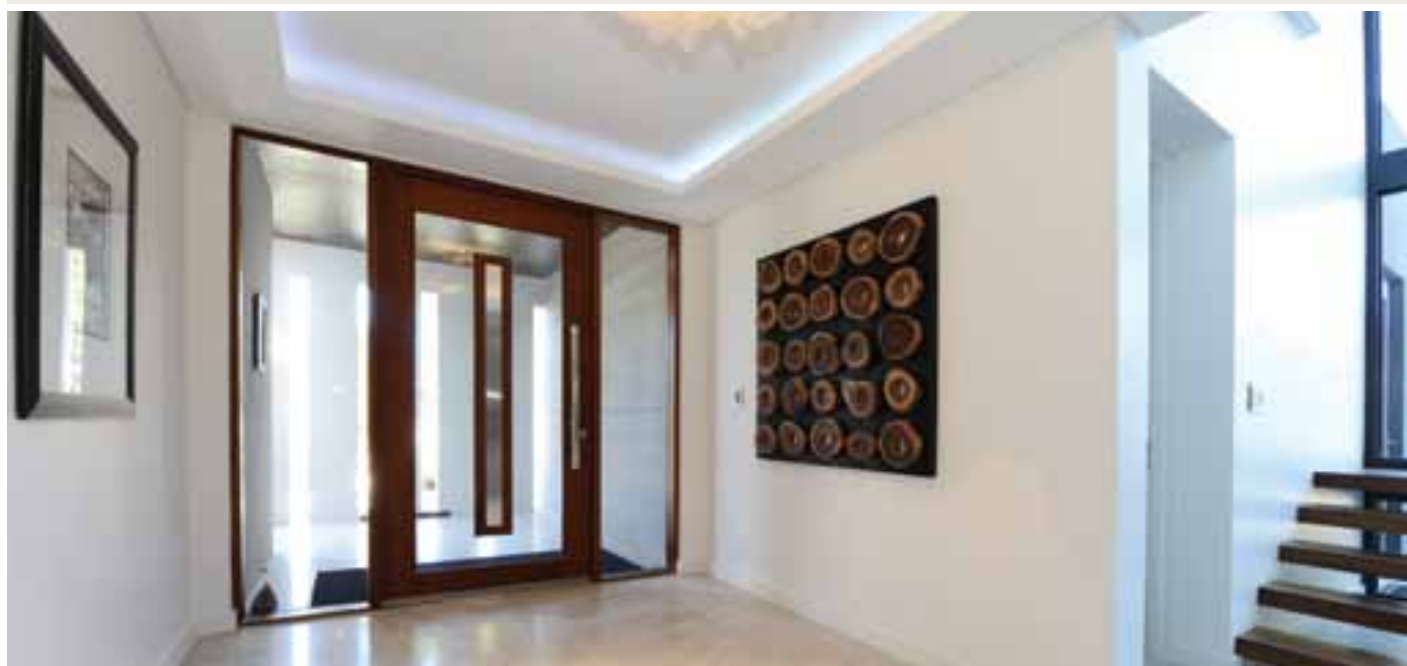

Entrance Pull Handles > Pull Handle Lock Kits

See Page 70 for Care and Maintenance

Double Turn Lock Kits

1182 Round
46mm Ø plates
57mm Backset Lock



Shortcase

Finishes: BN, SC, PC, OF

1183
46mm Ø roses
60mm Backset Lock



Longcase

1184
51 × 51mm Plates
60mm Backset Lock



Longcase

1258
60 × 30mm Plates
60mm Backset Lock



Longcase

1259
60 × 30mm Plates
30mm Backset Lock



7093 Pull Handle
1184 Lock Kit

Pull Handle Lock Kit Rollerbolt Alternative

Are you looking for a lock that:

- » Won't blow open in the wind
- » Doesn't need to be slammed closed

Then look no further than the latest kits from Zanda

- » With a neat compact thumb turn action that retracts a positive latch
- » Specifically designed for Australian conditions
- » All kits include Eurolock, cylinder and turn, double turn set and escutcheons
- » Packers also available to suit aluminium frames (See page 127)
- » Retract latch and deadbolt off key snib from inside (longcase only)



7092 Pull Handle
1183 Lock Kit

Entrance Pull Handles > Pull Handle Lock Kits

See Page 70 for Care and Maintenance

Uni-Turn Lock Kits



- » Minimalistic escutcheon design to complement slim-line pull handles
- » New single turn design guaranteed to eliminate binding
- » Brushed Nickel and Satin Chrome finishes with greater corrosion resistance
- » Save time on installation, with square drive fixing screws suited to aluminium joinery industry
- » Available to order in a range of special finishes
- » Packers, extended strike plates and rebate kits available to suit (see page 127)



30



When first impressions
are paramount.

Entrance Pull Handles > Pull Handle & Lock Kit Combinations

Pull Handle Lock Kit Combo Options

Polo

Nitro

Omega

Round

Square

1221
560mm crs
600mm o/a

1238
575mm crs
600mm o/a

1240
400mm crs
600mm o/a

1232
400mm crs
600mm o/a

1231
426mm crs
600mm o/a

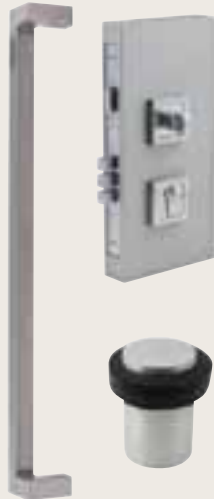

All kits include: 1 x Pair of 600mm Back to Back Pull Handles, 1 x Double Turn Lock Kit & 1 x 60x38mm Door Stop



DOOR FURNITURE - VISCA

Manufactured in the heart of Italy, Visca is a remarkable collection by some of Europe's most esteemed designers.

All Visca products are made of Solid Brass or Stainless Steel and come in a variety of top quality finishes.



Handing for Single/Dummy Handles



Left Hand

Right Hand

32

ZANDA
ARCHITECTURAL HARDWARE



VISCA

NEW

Polo

DUE NOVEMBER 2015

- 8162 Lever Set
- 8184 Passage Set
- 8184 PR Privacy Set
- 8183 Dummy Lever (Specify handing)



Finishes: BN, OF

Polo - Nero

DUE NOVEMBER 2015

- 8160 Lever Set
- 8180 Passage Set
- 8180 PR Privacy Set
- 8179 Dummy Lever (Specify handing)



Black Wooden Insert
 Finishes: BN, OF

Polo Product Suite

Create design consistency by choosing Polo Entrance and Cabinet Handles throughout your house:



See page 107 for Polo Cabinet Handles.

Available in 158mm, 192mm & 226mm lengths



See page 17 for Polo Entrance Pull Handles. Available in 300mm, 450mm, 600mm, 900mm & 1800mm lengths.



See page 70 for matching square door stops.

34

ZANDA
ARCHITECTURAL HARDWARE



Feel it, and then you'll know this Italian range is superb quality. And for your peace of mind, the Visca range comes with a lifetime warranty.

Door Furniture > Visca

VISCA

Alpha

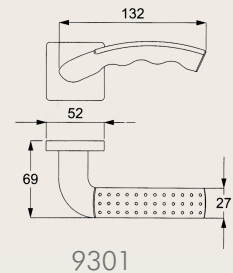

9301

- 9301 Leverset only
- 9301 PA Passage Set
- 9301 PR Privacy Set
- 9301 E Entrance Set

Finish: C/SN (Two-toned)

Zeta

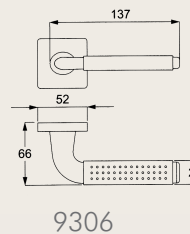

9306

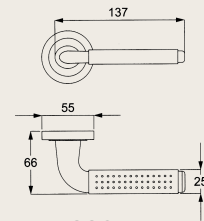

9305

- Round Rose
- 9305 Leverset only
 - 9305 PA Passage Set
 - 9305 PR Privacy Set
 - 9305 E Entrance Set

- Square Rose
- 9306 Leverset only
 - 9306 PA Passage Set
 - 9306 PR Privacy Set
 - 9306 E Entrance Set

- Longplate
- 9307 Longplate only, with keyhole
 - 9307 E Longplate Entrance Set

Finish: C/SN (Two-toned)

36

ZANDA
ARCHITECTURAL HARDWARE



VISCA

Axis

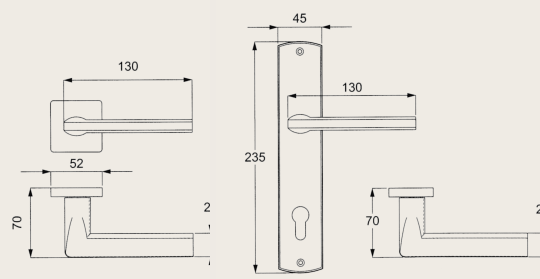

9321

9322

Square Rose
9321 Leverset only
9321 PA Passage Set
9321 PR Privacy Set
9321 E Entrance Set

Longplate
9322 Longplate only
9322 PA Passage Set
9322 PR Privacy Set

Designed specifically
for the 'Back to Basics'
minimalist.

Finish: SN

Genesis

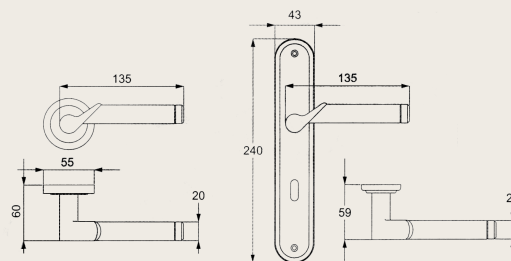
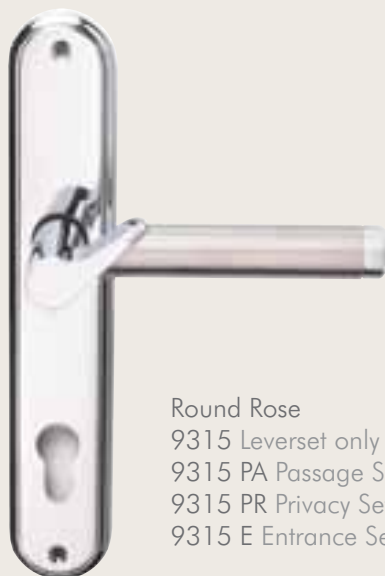

9315

9317

Round Rose
9315 Leverset only
9315 PA Passage Set
9315 PR Privacy Set
9315 E Entrance Set

Longplate
9317 Longplate only with Euro keyhole
9317 E Longplate Entrance Set

Finish: P/SS (Two-toned)

38

ZANDA
ARCHITECTURAL HARDWARE

Door Furniture > Visca

VISCA

Stroud



9325

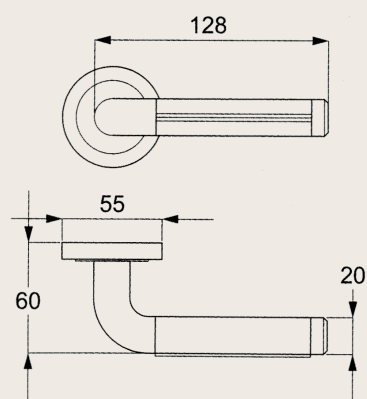

9325 Lever Set Only
9325 PA Passage Set
9325 PR Privacy Set

Option of Black or Brown Leather

Available in Chrome Plate, Polished Brass
& Satin Nickel Finishes

Breathtaking
Elegance.



DOOR FURNITURE - ASTRON



Clean simplistic lines combined with a superb finish make Astron the perfect choice for any home, apartment or office. The Astron range is for people who are wanting more. They're looking for more ways to express themselves and find benefit from the peace of mind of knowing that Astron is fully backed for its entire life. Leave a lasting impression with Astron.



- 41 Prisma, Matrix
- 42 Quattro, Quantum
- 43 Sterling, Square Acc.
- 44 Avante, Streamline
- 45 Titan, Vector
- 47 Qube, Juno
- 49 Apollo, Spectra
- 51 Luna, Nova
- 52 Astron Acc.

Handing for Single/Dummy Handles



Left Hand

Right Hand

40

 ZANDA
ARCHITECTURAL HARDWARE

Our Astron Series door furniture
is perfect for the modern home.



- » **Rose Passage Set** - includes Leverset & 1131 Latch.
- » **Rose Privacy Set** - includes Leverset, 1131 latch & 7032 Privacy Set
- » **Rose Dummy Lever** - includes single Lever, 1152 Dummy Mount & 7056 Blank Escutcheon
- » **Rose Entrance Set** - includes Leverset, escutcheon, 1143 Mortice Lock & cylinder of choice
- » **Longplate Passage Set** - includes Longplate & 1131 Latch
- » **Longplate Privacy Set** - includes Longplate, 1110 Bathroom Lock & 8055 Privacy Turn
- » **Longplate Dummy Lever** - includes single Longplate & 1137 Dummy Mount
- » **Longplate Entrance Set** - includes Longplate, 1143 Mortice Lock & cylinder of choice

Door Furniture > Astron

ASTRON

FEATURES:

- » Lifetime Warranty – your assurance of quality
- » Available in Brushed Nickel & Satin Chrome finishes with others made to order
- » Modern European styling with superb ergonomic designs for user comfort
- » Through door bolts and grub screws for an extremely secure fix

Prisma

- 8133 Leverset only
- 8132 Passage Set
- 8133 PR Privacy Set
- 8134 Dummy Set (LH or RH)
- 8133 E Entrance Set

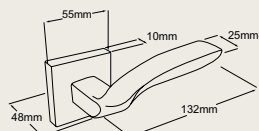

Prisma Longplate

- 8135 Longplate only
- 8135 E85 Longplate with Euro 85 keyhole



- 8135 PA Passage Set
- 8135 PR Privacy Set
- 8135 D Dummy Set (LH or RH)
- 8135 E Entrance Set

240 x 45 x 10mm Longplate Size

Finishes: BN, SC, PC, OF

Matrix

- 8129 Leverset only
- 8128 Passage Set
- 8129PR Privacy Set
- 8130 Dummy Set (LH or RH)
- 8128E Entrance Set

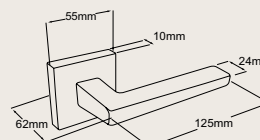

Matrix Longplate

- 8131 Longplate only
- 8131 E85 Longplate with Euro 85 keyhole

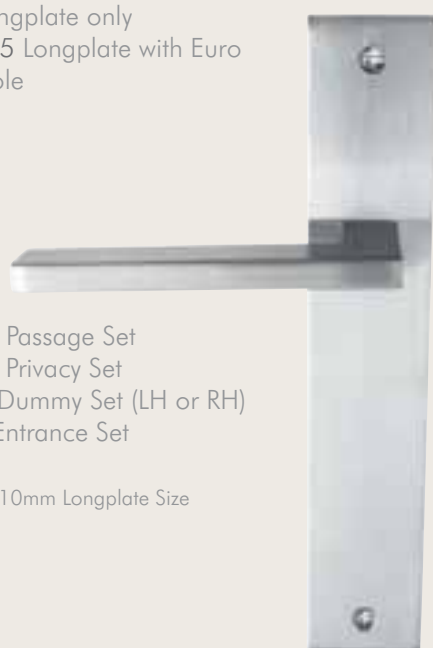

- 8131 PA Passage Set
- 8131 PR Privacy Set
- 8131 D Dummy Set (LH or RH)
- 8131 E Entrance Set

240 x 45 x 10mm Longplate Size

Finishes: BN, SC, PC, OF

See page 52 for Longplate Options

- » **Rose Passage Set** - includes Leverset & 1131 Latch.
- » **Rose Privacy Set** - includes Leverset, 1131 latch & 8101 Privacy Set
- » **Rose Dummy Lever** - includes single Lever, 1152 Dummy Mount & 8136 Blank Escutcheon
- » **Rose Entrance Set** - includes Leverset, escutcheon, 1143 Mortice Lock & cylinder of choice
- » **Longplate Passage Set** - includes Longplate & 1131 Latch
- » **Longplate Privacy Set** - includes Longplate, 1110 Bathroom Lock & 8055 Privacy Turn
- » **Longplate Dummy Lever** - includes single Longplate & 1137 Dummy Mount
- » **Longplate Entrance Set** - includes Longplate, 1143 Mortice Lock & cylinder of choice

Door Furniture > Astron

ASTRON

FEATURES:

- » Lifetime Warranty – your assurance of quality
- » Available in Brushed Nickel & Satin Chrome finishes with others made to order
- » Modern European styling with superb ergonomic designs for user comfort
- » Through door bolts and grub screws for an extremely secure fix

Quattro

- 8100 Leverset only
- 8099 Passage Set
- 8099 PR Privacy Set
- 8114 Dummy Set (LH or RH)
- 8100 E Entrance Set

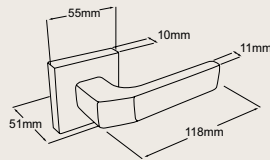

LOW PROJECTION
ONLY 52MM

Quantum

- 8110 Leverset only
- 8109 Passage Set
- 8110 PR Privacy Set
- 8115 Dummy Set (LH or RH)
- 8110 E Entrance Set

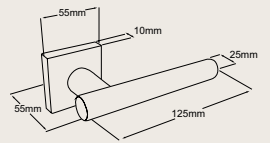

Finishes: SC, PC, OF

Quattro Longplate

- 8126 Longplate only
- 8126 E85 Longplate with Euro 85 keyhole



- 8126 PA Passage Set
- 8126 PR Privacy Set
- 8126 D Dummy Set (LH or RH)
- 8126 E Entry Set

240 x 45 x 10mm Longplate Size

Finishes: BN, SC, PC, OF



See page 52 for Longplate Options

- » **Rose Passage Set** - includes Leverset & 1131 Latch.
- » **Rose Privacy Set** - includes Leverset, 1131 latch & 8101 Privacy Set
- » **Rose Dummy Lever** - includes single Lever, 1152 Dummy Mount & 8136 Blank Escutcheon
- » **Rose Entrance Set** - includes Leverset, escutcheon, 1143 Mortice Lock & cylinder of choice
- » **Longplate Passage Set** - includes Longplate & 1131 Latch
- » **Longplate Privacy Set** - includes Longplate, 1110 Bathroom Lock & 8055 Privacy Turn
- » **Longplate Dummy Lever** - includes single Longplate & 1137 Dummy Mount
- » **Longplate Entrance Set** - includes Longplate, 1143 Mortice Lock & cylinder of choice

Door Furniture > Astron

ASTRON

FEATURES:

- » Lifetime Warranty – your assurance of quality
- » Available in Brushed Nickel & Satin Chrome finishes with others made to order
- » Modern European styling with superb ergonomic designs for user comfort
- » Through door bolts and grub screws for an extremely secure fix

Sterling

- 7318 Leverset only
- 7319 Passage Set
- 7320 Privacy Set
- 7318 D Dummy Set (LH or RH)
- 7321 Entrance Set

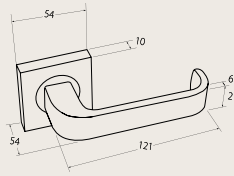

NEW

Privacy - Square

- 8101
- 55mm Plates
- 60mm Backset Bolt



Finishes: BN, SC, PC, OF



Sterling Longplate

- 8170 Longplate only
- 8170 E85 Longplate with Euro
- 85 keyhole



- 8170 PA Passage Set
- 8170 PR Privacy Set
- 8170 D Dummy Set (LH or RH)
- 8170 E Entrance Set

240 x 45 x 10mm Longplate Size

NEW

Finishes: BN, SC, PC, OF

Escutcheons

55 x 55 x 10mm Plate Size

Euro

Oval

Blank



8102 E

8102 O

8136

Finishes: BN, SC, PC, OF

- » **Rose Passage Set** - includes Leverset & 1131 Latch.
- » **Rose Privacy Set** - includes Leverset, 1131 latch & 7032 Privacy Set
- » **Rose Dummy Lever** - includes single Lever, 1152 Dummy Mount & 7056 Blank Escutcheon
- » **Rose Entrance Set** - includes Leverset, escutcheon, 1143 Mortice Lock & cylinder of choice
- » **Longplate Passage Set** - includes Longplate & 1131 Latch
- » **Longplate Privacy Set** - includes Longplate, 1110 Bathroom Lock & 8055 Privacy Turn
- » **Longplate Dummy Lever** - includes single Longplate & 1137 Dummy Mount
- » **Longplate Entrance Set** - includes Longplate, 1143 Mortice Lock & cylinder of choice

Door Furniture > Astron

ASTRON

FEATURES:

- » Lifetime Warranty – your assurance of quality
- » Available in Brushed Nickel & Satin Chrome finishes with others made to order
- » Modern European styling with superb ergonomic designs for user comfort
- » Through door bolts and grub screws for an extremely secure fix

Avante

- 8091 Leverset only
- 8137 Passage Set
- 8091 PR Privacy Set
- 8138 Dummy Set (LH or RH)
- 8091 E Entrance Set

55 x 55 x 11mm Rose Size

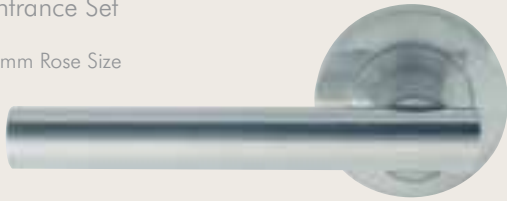
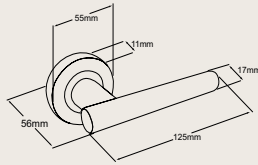

Avante Longplate

- 8090 Longplate only
- 8090 E85 Longplate with Euro 85 keyhole

- 8103 PA Passage Set
- 8103 PR Privacy Set
- 8103 D Dummy Set (LH or RH)
- 8090 E Entrance Set

233 x 32 x 10mm Longplate Size

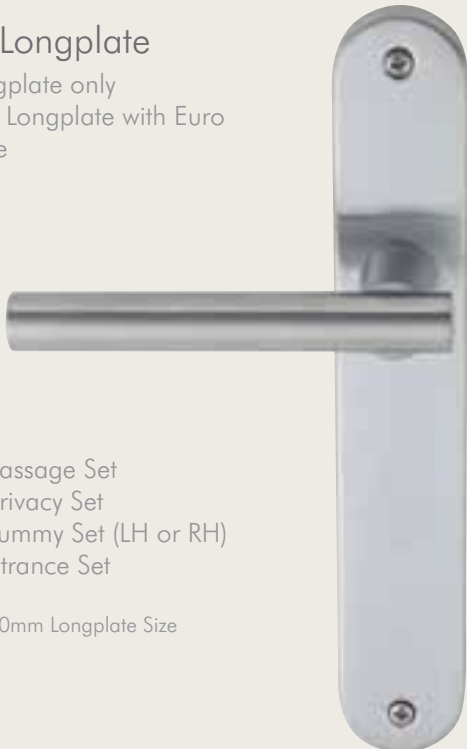

Minimum Lock Backset 35mm
Use 1131 Tubular Latch with Avante.

Finishes: SC, PC, OF

Streamline

- 7313 Leverset only
- 7314 Passage Set
- 7315 Privacy Set
- 7313 D Dummy Set (LH or RH)
- 7316 Entrance Set

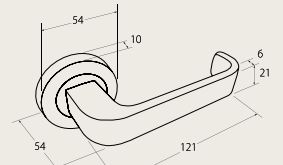

NEW

Streamline Longplate

- 7317 Longplate only
- 7317 E85 Longplate with Euro 85 keyhole

- 7317 PA Passage Set
- 7317 PR Privacy Set
- 7317 D Dummy Set (LH or RH)
- 7317 E Entrance Set

233 x 32 x 10mm Longplate Size



NEW

Finishes: BN, SC, PC, OF

- » **Rose Passage Set** - includes Leverset & 1131 Latch
- » **Rose Privacy Set** - includes Leverset, 1131 latch & 7032 Privacy Set
- » **Rose Dummy Lever** - includes single Lever, 1152 Dummy Mount & 7056 Blank Escutcheon
- » **Rose Entrance Set** - includes Leverset, escutcheon, 1143 Mortice Lock & cylinder of choice
- » **Longplate Passage Set** - includes Longplate & 1131 Latch
- » **Longplate Privacy Set** - includes Longplate, 1110 Bathroom Lock & 8055 Privacy Turn
- » **Longplate Dummy Lever** - includes single Longplate & 1137 Dummy Mount
- » **Longplate Entrance Set** - includes Longplate, 1143 Mortice Lock & cylinder of choice

Door Furniture > Astron

ASTRON

FEATURES:

- » Lifetime Warranty – your assurance of quality
- » Available in Brushed Nickel & Satin Chrome finishes with others made to order
- » Modern European styling with superb ergonomic designs for user comfort
- » Through door bolts and grub screws for an extremely secure fix

Titan

- 7113 Leverset only
- 7114 Passage Set
- 7115 Privacy Set
- 7113 D Dummy Set (LH or RH)
- 7117 Entrance Set

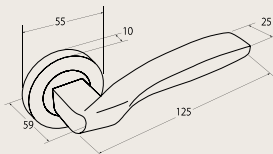

Titan Longplate

- 7112 Longplate only
- 7112 E85 Longplate with Euro 85 keyhole



- 7112 PA Passage Set
- 7112 PR Privacy Set
- 7112 D Dummy Set (LH or RH)
- 7116 Entrance Set

233 x 32 x 10mm Longplate Size

Finishes: BN, SC, PC, OF

Vector

- 7106 Leverset only
- 7107 Passage Set
- 7108 Privacy Set
- 7106 D Dummy Set (LH or RH)
- 7110 Entrance Set

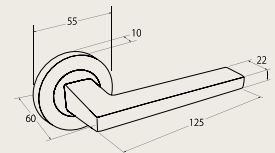

Vector Longplate

- 7105 Longplate only
- 7105 E85 Longplate with Euro 85 keyhole



- 7105 PA Passage Set
- 7105 PR Privacy Set
- 7105 D Dummy Set (LH or RH)
- 7109 Entrance Set

233 x 32 x 10mm Longplate Size

Finishes: BN, SC, PC, OF

See page 52 for Long Plate Options

46

ZANDA
ARCHITECTURAL HARDWARE

Success is the untiring
pursuit of perfection



- » **Rose Passage Set** - includes Leverset & 1131 Latch
- » **Rose Privacy Set** - includes Leverset, 1131 latch & 7032 Privacy Set
- » **Rose Dummy Lever** - includes single Lever, 1152 Dummy Mount & 7056 Blank Escutcheon
- » **Rose Entrance Set** - includes Leverset, escutcheon, 1143 Mortice Lock & cylinder of choice
- » **Longplate Passage Set** - includes Longplate & 1131 Latch
- » **Longplate Privacy Set** - includes Longplate, 1110 Bathroom Lock & 8055 Privacy Turn
- » **Longplate Dummy Lever** - includes single Longplate & 1137 Dummy Mount
- » **Longplate Entrance Set** - includes Longplate, 1143 Mortice Lock & cylinder of choice

Door Furniture > Astron

ASTRON

FEATURES:

- » Lifetime Warranty – your assurance of quality
- » Available in Brushed Nickel & Satin Chrome finishes with others made to order
- » Modern European styling with superb ergonomic designs for user comfort
- » Through door bolts and grub screws for an extremely secure fix

Qube

- 7058 Leverset only
- 7059 Passage Set
- 7060 Privacy Set
- 7058 D Dummy Set (LH or RH)
- 7085 Entrance Set

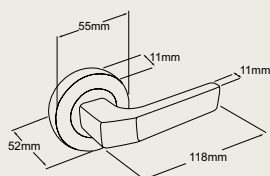

LOW PROJECTION
ONLY 52MM

Qube Longplate

- 7057 Longplate only
- 7057 E85 Longplate with Euro 85 keyhole

- 7057 PA Passage Set
- 7057 PR Privacy Set
- 7057 D Dummy Set (LH or RH)
- 7061 Entrance Set

233 x 32 x 10mm Longplate Size



Finishes: BN, SC, PC, OF

Juno

- 7019 Leverset only
- 7036 Passage Set
- 7037 Privacy Set
- 7019 D Dummy Set (LH or RH)
- 7081 Entrance Set

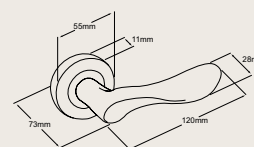

Juno Longplate

- 7046 Longplate only
- 7046 E85 Longplate with Euro 85 keyhole

- 7046 PA Passage Set
- 7046 PR Privacy Set
- 7046 D Dummy Set (LH or RH)
- 7038 Entrance Set

233 x 32 x 10mm Longplate Size

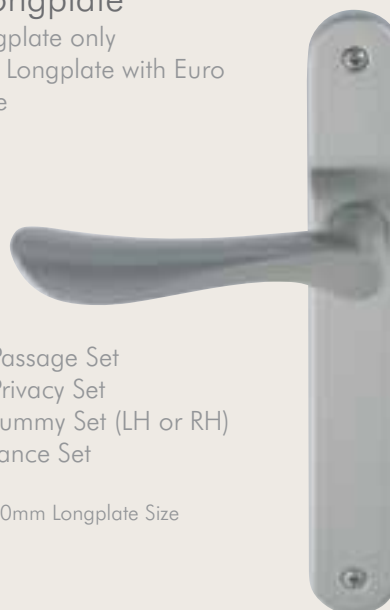

Finishes: BN, SC, TG, PC, OF

See page 52 for Long Plate Options

48

ZANDA
ARCHITECTURAL HARDWARE



- » **Rose Passage Set** - includes Leverset & 1131 Latch
- » **Rose Privacy Set** - includes Leverset, 1131 latch & 7032 Privacy Set
- » **Rose Dummy Lever** - includes single Lever, 1152 Dummy Mount & 7056 Blank Escutcheon
- » **Rose Entrance Set** - includes Leverset, escutcheon, 1143 Mortice Lock & cylinder of choice
- » **Longplate Passage Set** - includes Longplate & 1131 Latch
- » **Longplate Privacy Set** - includes Longplate, 1110 Bathroom Lock & 8055 Privacy Turn
- » **Longplate Dummy Lever** - includes single Longplate & 1137 Dummy Mount
- » **Longplate Entrance Set** - includes Longplate, 1143 Mortice Lock & cylinder of choice

Door Furniture > Astron

ASTRON

FEATURES:

- » Lifetime Warranty – your assurance of quality
- » Available in Brushed Nickel & Satin Chrome finishes with others made to order
- » Modern European styling with superb ergonomic designs for user comfort
- » Through door bolts and grub screws for an extremely secure fix

Apollo

- 7015 Leverset only
- 7033 Passage Set
- 7034 Privacy Set
- 7015 D Dummy Set (LH or RH)
- 7080 Entrance Set

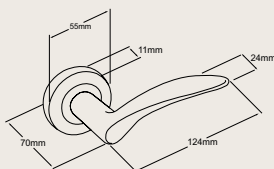

Spectra

- 7050 Leverset only
- 7051 Passage Set
- 7052 Privacy Set
- 7050 D Dummy Set (LH or RH)
- 7084 Entrance Set

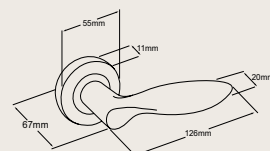

Apollo Longplate

- 7045 Longplate only
- 7045 E85 Longplate with Euro 85 keyhole



- 7045 PA Passage Set
- 7045 PR Privacy Set
- 7045 D Dummy Set (LH or RH)
- 7035 Entrance Set

233 x 32 x 10mm Longplate Size

Finishes: BN, SC, TG, PC, OF

Spectra Longplate

- 7049 Longplate only
- 7049 E85 Longplate with Euro 85 keyhole



- 7049 PA Passage Set
- 7049 PR Privacy Set
- 7049 D Dummy Set (LH or RH)
- 7053 Entrance Set

233 x 32 x 10mm Longplate Size

Finishes: BN, SC, PC, TG, OF

See page 52 for Long Plate Options

50

ZANDA
ARCHITECTURAL HARDWARE



- » **Rose Passage Set** - includes Leverset & 1131 Latch
- » **Rose Privacy Set** - includes Leverset, 1131 latch & 7032 Privacy Set
- » **Rose Dummy Lever** - includes single Lever, 1152 Dummy Mount & 7056 Blank Escutcheon
- » **Rose Entrance Set** - includes Leverset, escutcheon, 1143 Mortice Lock & cylinder of choice
- » **Longplate Passage Set** - includes Longplate & 1131 Latch
- » **Longplate Privacy Set** - includes Longplate, 1110 Bathroom Lock & 8055 Privacy Turn
- » **Longplate Dummy Lever** - includes single Longplate & 1137 Dummy Mount
- » **Longplate Entrance Set** - includes Longplate, 1143 Mortice Lock & cylinder of choice

Door Furniture > Astron

ASTRON

FEATURES:

- » Lifetime Warranty – your assurance of quality
- » Available in Brushed Nickel & Satin Chrome finishes with others made to order
- » Modern European styling with superb ergonomic designs for user comfort
- » Through door bolts and grub screws for an extremely secure fix

Luna

- 7030 Leverset only
- 7042 Passage Set
- 7043 Privacy Set
- 7030 D Dummy Set (LH or RH)
- 7083 Entrance Set

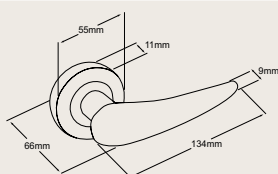

Nova

- 7022 Leverset only
- 7039 Passage Set
- 7040 Privacy Set
- 7022 D Dummy Set (LH or RH)
- 7082 Entrance Set

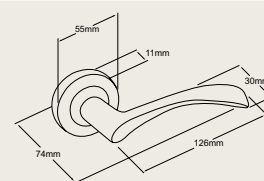

Use 110mm Door Stops with Nova furniture.

Luna Longplate

- 7048 Longplate only
- 7048 E85 Longplate with Euro 85 keyhole

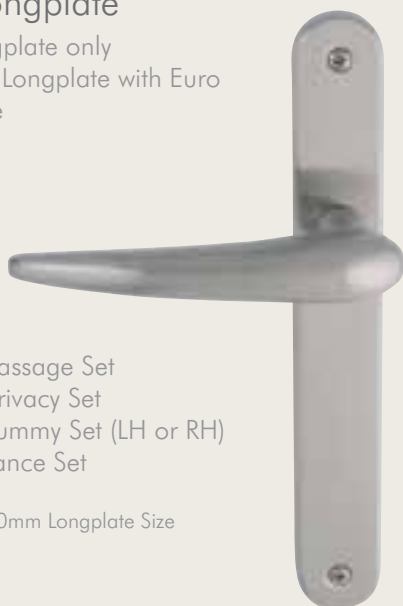

- 7048 PA Passage Set
- 7048 PR Privacy Set
- 7048 D Dummy Set (LH or RH)
- 7044 Entrance Set

233 x 32 x 10mm Longplate Size

Finishes: BN, SC, PC, TG, OF

Nova Longplate

- 7047 Longplate only
- 7047 E85 Longplate with Euro 85 keyhole



- 7047 PA Passage Set
- 7047 PR Privacy Set
- 7047 D Dummy Set (LH or RH)
- 7041 Entrance Set

233 x 32 x 10mm Longplate Size

Use 110mm Door Stops with Nova furniture.

Finishes: BN, SC, PC, OF

See page 52 for Long Plate Options

Door Furniture > Astron

ASTRON

Tubular Latch

1131 60mm B/S



Finishes: BN, SC, AB, PC, BLK, TG, OF



Privacy Sets

60mm Backset Only
6mm Spindle
52.5mm Rose

Sold as complete kit only

7032

7076 Indicator



Finishes: BN, SC, PC

Escutcheons

7020 55mm Rose, Concealed Fix

7056 Dummy Blank



Finishes: BN, SC, PC, TG, OF

Dummy Handle Fixing Mounts

1152 8mm Spindle
32mm Ø base

1137 7.6mm Spindle
26mm Ø base
Use with longplates



1151

Strike and Recess Box



Plate Options

All Longplates 233x32mm



Latch

48 Euro

85 Euro



- » Suitable for aluminium joinery
- » Can be powder coated to match your joinery
- » Compatible with 30mm lock backset (except Luna and Avante 35mm)
- » Hardware can be modified to suit other locking systems including oval profile cylinder
- » Hardware can be modified to multi-point locks. To modify Astron longplates, use code 1274. These codes must be specified at time of ordering as the modification has to be done in our factory. A small charge applies for this modification.

DOOR FURNITURE - FUTURA



Futura, as the name implies, is an exquisite range of door furniture that harnesses the past and heralds the future. Using sleek design concepts, this range embodies the form and function that are the hallmarks of Zanda products. The subtle infusion of bright chrome compliments the alluring beauty of brushed nickel to make the Futura range breathtakingly elegant.



- 54 Volt, Entro
- 55 Luxe, Epic
- 56 Stride,
Futura Accessories

Handing for Single/Dummy Handles



Left Hand

Right Hand

Door Furniture > Futura

FUTURA

NEW

Volt

- 10030 Leverset Only
- 10031 Passage Set
- 10032 Privacy Set
- 10033 Dummy Set (Non handed)
- 10034 Entrance Set

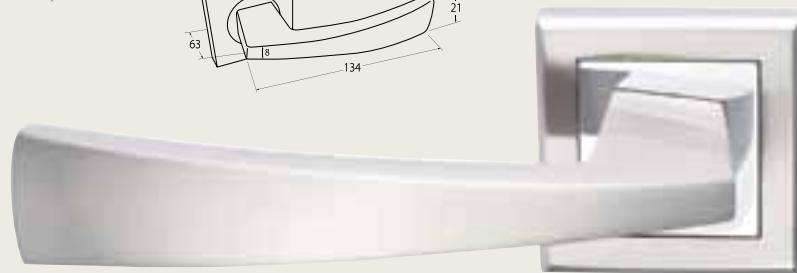
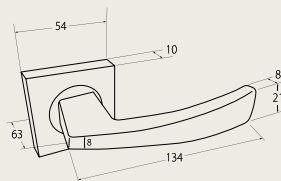

Finish: BN/CP (Two-toned)

Entro

- 10050 Leverset Only
- 10051 Passage Set
- 10052 Privacy Set
- 10053 Dummy Set (Non handed)
- 10054 Entrance Set

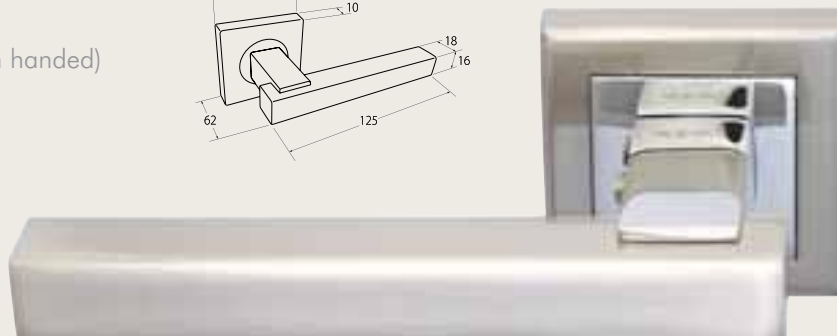
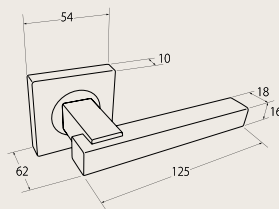

Finish: BN/CP (Two-toned)

FEATURES:

- » 15 Year Warranty – your assurance of quality
- » Brushed Nickel designer finish with a subtle dash of Chrome - perfect to tie in with your chrome accessories
- » Through door bolts for secure fixing - handles won't twist out of square with time
- » Passage Set - includes Leverset & 1131 Latch.
- » Privacy Set - includes Leverset & Integrated Privacy Latch
- » Dummy Lever - includes single Lever & 10687 Dummy Mount
- » Entrance Set - includes Leverset, escutcheon, 1143 Mortice Lock & cylinder of choice

Door Furniture > Futura

FUTURA

NEW

Luxe

- 10010 Leverset Only
- 10011 Passage Set
- 10012 Privacy Set
- 10013 Dummy Set (specify handing, L or R)
- 10014 Entrance Set

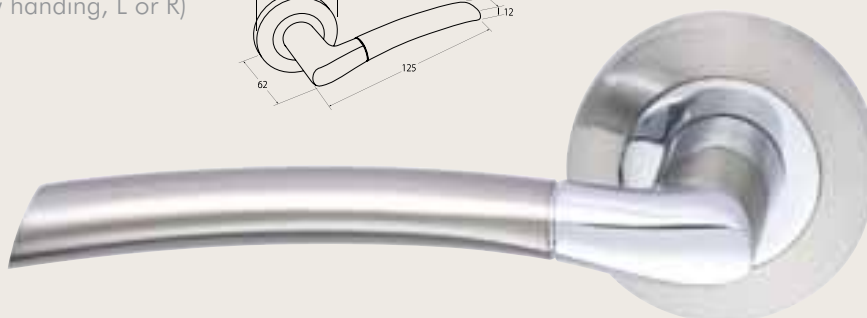
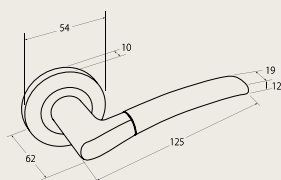

Finish: BN/CP (Two-toned)

Epic

- 10020 Leverset Only
- 10021 Passage Set
- 10022 Privacy Set
- 10023 Dummy Set (Non handed)
- 10024 Entrance Set

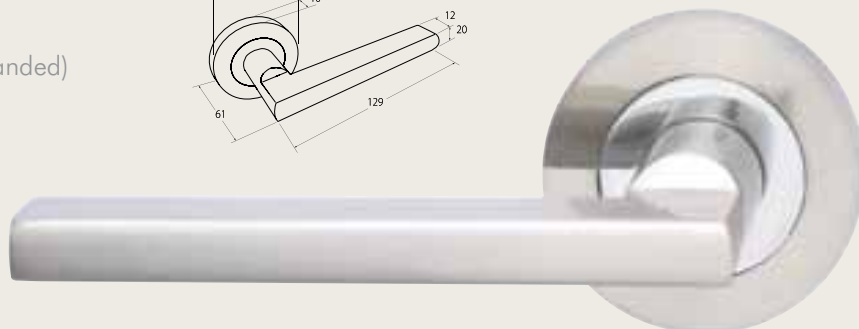
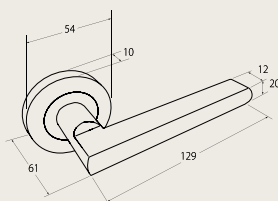

Finish: BN/CP (Two-toned)

56

ZANDA
ARCHITECTURAL HARDWARE

FEATURES:

- » 15 Year Warranty – your assurance of quality
- » Brushed Nickel designer finish with a subtle dash of Chrome - perfect to tie in with your chrome accessories
- » Through door bolts for secure fixing - handles won't twist out of square with time
- » Passage Set - includes Leverset & 1131 Latch.
- » Privacy Set - includes Leverset & Integrated Privacy Latch
- » Dummy Lever - includes single Lever & 10687 Dummy Mount
- » Entrance Set - includes Leverset, escutcheon, 1143 Mortice Lock & cylinder of choice

Door Furniture > Futura

FUTURA

NEW

Stride

- 10040 Leverset Only
- 10041 Passage Set
- 10042 Privacy Set
- 10043 Dummy Set (Non handed)
- 10044 Entrance Set

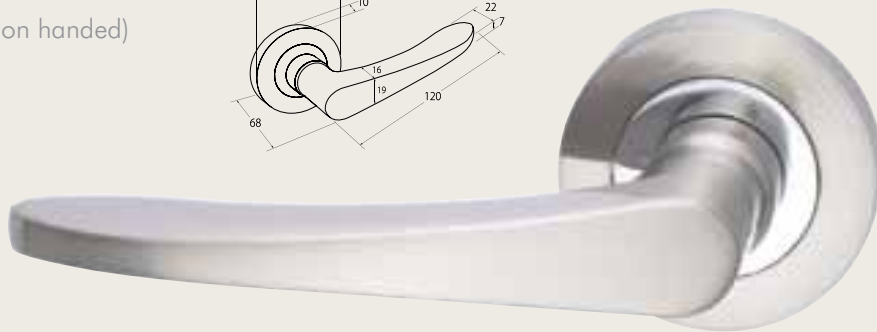
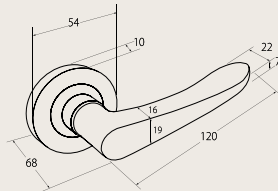

Finish: BN/CP (Two-toned)

Privacy Sets

10684 Integrated Privacy Kit
(this comes as standard with Futura Privacy Sets)

9034
Separate
Privacy Kit
(add to
passage set)



Finish: BN

Tubular Latch

1131 60mm B/S



Finish: BN

Adaptor Plates for Retro-fitting

65mm x 10mm plate
Can be used to fit over
a 55mm hole size
Sold in pairs

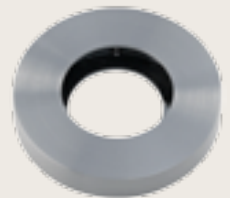

10063 Suits Passage Set
10064 Suits Privacy Set

Finish: BN

Dummy Spindle

1152 8mm spindle
32mm Ø base



Escutcheons

9035 Round, 54mm Rose
10062 Square, 54 x 54mm Rose



Finish: BN/CP (Two-toned)

10063 Pictured with
Epic Leverset



DOOR FURNITURE - TRIAD



Match in your Passage, Privacy and Entrance key-in-lever sets so there is a consistency in design throughout your whole project by using Triad. Simplistic, stylish and exciting design accompanied by quality manufacturing – expect nothing less from Triad.



- 58 Trident
- 58 Mace
- 58 Sceptre
- 58 Slimline Deadbolts

FEATURES:

- » 15 Year Warranty – tested for over 300,000 cycles
- » Through door bolts for secure fixing - won't sag over time
- » 65mm Rose Size—will replace most existing locks
- » Passage, Privacy, Entrance & Combination Sets include latches
- » Combination Set includes Entrance Set & matching Slimline Double Deadbolt

Door Furniture > Triad

TRIAD

Trident

- 11508 Passage Set
- 11509 Privacy Set
- 11510 Dummy Set (Non handed)
- 11511 Entrance Set (Pictured)
- 11522 Combination Set

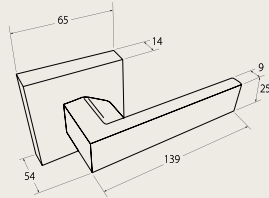

Finish: BN

Mace

- 11504 Passage Set
- 11505 Privacy Set
- 11506 Dummy Set (Non handed)
- 11507 Entrance Set (Pictured)
- 11521 Combination Set

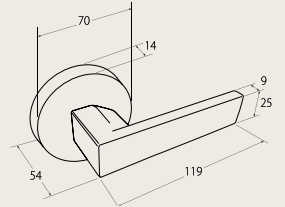

Finish: BN

Sceptre

- 11500 Passage Set
- 11501 Privacy Set
- 11502 Dummy Set (Non handed)
- 11503 Entrance Set (Pictured)
- 11520 Combination Set

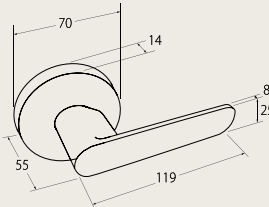

Finish: BN

Slimline Deadbolts

- Square**
- 11516 Single Cylinder (Key/Turn)
 - 11517 Double Cylinder (Key/Key)



- Round**
- 11518 Single Cylinder (Key/Turn)
 - 11519 Double Cylinder (Key/Key)



Finish: BN

DOOR FURNITURE - JURA



Jura is a good quality range of handles that is both elegant and fantastic value. Unique styling and economy pricing makes this range ideal for the entry level new build and renovation markets.



- 60 Talon
- 60 Helix
- 60 Corbel
- 60 Apex
- 61 Alto
- 61 Kona
- 61 Cyclo
- 62 Manta
- 62 Zenith
- 62 Deadbolts

Handing for Single/Dummy Handles



Left Hand

Right Hand

60

ZANDA
ARCHITECTURAL HARDWARE

FEATURES:

- » 10 Year Warranty – quality comes as standard every time
- » Brushed Nickel designer finish to compliment modern decor
- » 54 x 10mm Concealed Fix Rose
- » Passage Set - includes Leverset & 1131 Latch.
- » Privacy Set - includes Leverset & Integrated Privacy Latch
- » Dummy Lever - includes single Lever & 10687 Dummy Mount

Door Furniture > Jura Elite

JURA ELITE

NEW

Talon

- 9026 Leverset Only
- 9027 Passage Set
- 9028 Privacy Set
- 9026D Dummy Set (specify handing)



Finish: BN

Helix

- 9030 Leverset Only
- 9031 Passage Set
- 9032 Privacy Set
- 9030D Dummy Set (specify handing)



Finish: BN

Corbel

- 9022 Leverset Only
- 9023 Passage Set
- 9024 Privacy Set
- 9022D Dummy Set (specify handing)



Finish: BN

Apex

- 9018 Leverset Only
- 9019 Passage Set
- 9020 Privacy Set
- 9018D Dummy Set (specify handing)



Finish: BN

Accessories

Privacy Set

- 9034 60mm Backset
- 54 x 10mm Rose
- 5mm Spindle

For use when a separate privacy is required. All Privacy Sets above are integrated.

Finish: BN



10063 Suits Passage Sets

10064 Suits Privacy Sets

65 x 10mm screw on Adaptor Plate for Futura Rose (pair) For 54mm Hole Pattern



Apex Lever with 10063 Fitted

JURA

The Jura Range features 65mm Rose Diameter, bolt through fixing and inbuilt privacy system. Passage and Privacy Sets include adjustable Latch.

Alto

- 9005 Passage Set (Pictured)
- 9006 Privacy Set
- 9007 Dummy Single - Fixed (non handed)

Adjustable Latch 60 or 70mm B/S
Comes with all Passage and Privacy Sets.
Plastic Recess Box included with strike plate.



Kona

- 9008 Passage Set
- 9009 Privacy Set (Pictured)
- 9010 Dummy Single - Fixed (non handed)

Finishes: BN, with SS Rose Covers
Rebate Kit 1102A



Cyclo

- 9090 Cyclo Passage Set
- 9091 Cyclo Privacy Set
- 9092 Cyclo Dummy Single (non handed)
- 9093 Cyclo Entrance Set
- 9094 Cyclo Combination Set

Finishes: CP, PB, SS



62

ZANDA
ARCHITECTURAL HARDWARE

Door Furniture > Jura

JURA

The Jura Range features 65mm Rose Diameter, bolt through fixing and inbuilt privacy system. Passage and Privacy Sets include adjustable Latch.

Manta

- 9110 Passage Set
- 9111 Privacy Set
- 9112 Dummy Set (Non handed)
- 9113 Entrance Set
- 9114 Combination Set

Finishes: BN



Zenith

- 9100 Passage Set
- 9101 Privacy Set
- 9102 Dummy Set (Non handed)
- 9103 Entrance Set
- 9104 Combination Set

Finishes: BN



Deadbolts

9011 Key/Key



Finishes: BN
Rebate Kit 1102A

9012 Key/Turn



Sold as complete units only.
Adjustable bolt for 60 or 70mm B/S
C4 key profile Supplied with 3 keys
64mm rose
Concealed fix to exterior

SLIDING DOOR HARDWARE



- 64 Flush Pulls
- 64 Edge Pulls
- 64 Flush Rings
- 65 Flush Pull Kits
- 65 Sliding Door Euro Lock Kits
- 67 Verve Range
- 68 Cavity Suite Range
- 68 Italian Range



Sliding Door Hardware > Flush Pulls, Edge Pulls and Flush Rings



Flush Pulls

<p>5228 120 × 40mm 11mm depth</p>  <p>Finish: SS</p>	<p>5241 120 × 40mm 11mm depth</p>  <p>Finish: SS</p>	<p>5242 102 × 51mm 11mm depth</p>  <p>Finish: SS</p>	<p>5257 128 × 83mm 18mm depth</p>  <p>Finish: SS</p>	<p>5182 102 × 50mm 14mm depth</p>  <p>Finishes: SC, PB, OF Solid Brass Material</p>
---	---	---	--	--

Edge Pulls

<p>5259 Square Style 100 × 20mm</p>  <p>Finishes: SS, BLK</p>	<p>5267 Oval Style 100 × 20mm</p>  <p>Finish: SS</p>
---	--

Flush Rings

<p>5177 40 × 33mm</p>	
<p>5154 50 × 37mm</p>	
<p>5155 63 × 50mm</p> <p>Finishes: SC, PB Solid Brass Material</p>	

 <p>8088 Round Style 29mm diameter Finishes: BN, SC, PB</p>	 <p>5333 Square Style 29 × 29mm Finish: SS</p>
---	--

Sliding Door Hardware > Flush Pull Kits

Flush Pull Kits

5261
Square Style 102 x 51mm
Flush pulls & 100x20mm edge pull



5260
Oval 120 x 40mm
Flush pulls & 100x20mm edge pull



Finish: SS



Sliding Door Euro Lock Kits

1188 Oval Style
Minimum door thickness 36mm
120 x 40mm



1189 Square Style
Minimum door thickness 36mm
102 x 51mm



- Flush pull & escutcheon integrated into one unit.
- Each kit includes 3 pin 40mm double cylinder, two flush pulls, edge pull and 57mm backset lock
- Satin Stainless Steel



66

ZANDA
ARCHITECTURAL HARDWARE

Verve: Giving your sliding doors that “wow” factor.



Sliding Door Hardware > Verve Flush Pulls

NEW

Verve Flush Pulls

5304 200 × 37mm
5305 250 × 37mm
5306 300 × 37mm



FEATURES:

- 304 Grade stainless Steel construction
- 37mm narrow profile to suit aluminium doors
- Available with Euro keyholes for sliding entrance doors
- Concealed fixing - aesthetically appealing

Finishes: SS, PC, BLK

Verve Flush Pull Kits



5320 (pictured)
200 × 37mm
5321 250 × 37mm
5322 300 × 37mm

All Kits include
2 Verve Flush Pulls
& 5259 Edge Pull

Finishes: SS, BLK

Verve Sliding Door Lock Kits



1269 200 × 37mm
1270 250 × 37mm
1271 300 × 37mm

All Kits include 1290 Sliding
Door Lock, 38mm Euro Cylinder,
2 Euro punched Flush Pulls
& 100 × 20mm Edge Pull

Minimum door thickness 36mm

Finishes: SS, BLK

Sliding Door Hardware > Cavity Suite & Italian Range

Cavity Suite



SQUARE STYLE
5330-SS Passage Kit
5331-SS Privacy Kit (Pictured)
5332-SS Double Turn Kit



ROUND STYLE
5326-SS Passage Kit
5327-SS Privacy Kit (Pictured)
5328-SS Double Turn Kit

NEW

FEATURES:

- Flush turn design. Allows door to slide right back into cavity
- Standard 54mm hole template and instructions for fast and easy installation
- Suits 32-38mm door thickness
Extender kits available for thicker doors
- 60mm backset on privacy and double turn kits
- Stainless Steel construction and finish
- Every kit comes with complimentary 5333 edge pull (see page 64)

Italian Range

8105 Single Flush Pull
55 x 11mm



8107 Flush Pull Kit
29mm Edge Pull
55 x 11mm
Flush Pulls



Finishes: BN, SC, TG



8106
Privacy Kit, Includes: Turn, Escape, Edge Pull,
Privacy mortice lock, 50mm backset



Suits 34+mm doors. Countersunk flush pulls allow doors to fully recess inside cavity.

Finishes: BN, SC, TG

DOOR ACCESSORIES



- 70 Door Stops
- 71 Door Holders
- 73 Hinges
- 74 Reverse Barrel Bolts
Dust Socket
Security Door Bolt
Barrel Bolts
- 75 Flush Bolts
Panic Bolts
- 77 Wardrobe Accessories
- 78 Escutcheons, Knockers
- 79 Privacy Hardware
- 80 Aluminium Hooks
Cabin Hooks
Bannister Brackets
Door Viewer



Door Accessories > Door Stops

Floor Mounted

<p>5249 38x38mm 2 Piece</p>  <p>Finishes: BN, SA</p>	<p>5256 38x38mm</p>  <p>Complete with Screw & Dynabolt fix options.</p>	<p>5264 60x38mm</p> 	<p>5274 38x38mm</p>  <p>Finishes: BN, SA Complete with Screw & Dynabolt fix options.</p>	<p>5278 60x38mm</p> 
<p>14008 25mm Height 44mm Diameter</p>  <p>Finishes: BN, SC</p>	<p>14010 35mm Height 13mm Base 44mm Diameter</p> 	<p>14009 49mm Height 54 x 65mm Base</p> 	<p>5062 22mm Height 32 x 42mm Base</p>  <p>Finishes: BN, SC, PB, OF</p>	

Concealed Skirting Fix

	<p>5229 75mm Length Finishes: BN, SC</p>		<p>5262 19 x 19mm 80mm Length Finishes: BN, SC</p>
	<p>5240 85mm Length 16mm Diameter Finishes: BN, SC</p>		<p>5265* 110mm Length 20mm Diameter Finishes: BN, SC</p>

*110mm Doorstops are ideal in the situation where the door opens against a towel rail.

Door Accessories > Door Stops & Holders

Door Stop / Holder

5258
Engaged length 93mm



Can be powder coated to any standard Dulux colour. MOQ's may apply. (Matt White pictured below)



Finishes: BN, SC, PC

Door Holder

5133
Engaged length 88mm



Finishes: SC, PB

8067*
Engaged length 37mm



Finish: CP

Magnetic Door Stop

10500
50mm Diameter base
75mm projection

NEW



Finishes: BN, SC, PB

Foot Operated Door Holder

5063
170 x 34mm
26mm throw



Finishes: SC, PB

These Door Stops provide the perfect solution for areas where door opening is restricted. Toilets, showers, towel rails, tiled floors with underfloor heating or any other application where a floor or skirting mount stop is not suitable. You won't trip over these and installation is easy.

Hinge Pin Adjustable Door Stop

5277



Operates from approx 85 - 125 degrees using threaded adjuster.

The hinge pin door stop can be mounted on any loose pin hinges.

Overhead Door Stops

5263L
Use on doors hung as shown



5263R



- Screws to door head jamb.
- Angle of operation: Minimum 70°, Maximum 120°
- This is dependent of position on door jamb
- Stainless Steel finish
- 157 x 46mm

*Discontinued, limited stocks available

72

ZANDA
ARCHITECTURAL HARDWARE



Door Accessories > Hinges

Stainless Steel Hinges

Butt Hinge



- 5933 Fixed Pin
100 x 75 x 2.5mm
- 5934 Loose Pin
100 x 75 x 2.5mm
- 5931 Fixed Pin
100 x 100 x 2.5mm
- 5932 Loose Pin
100 x 100 x 2.5mm

316 Stainless Steel

- 5901 Loose Pin
100 x 75 x 2.5mm
- 5903 Fixed Pin
100 x 75 x 2.5mm
- 5910 Loose Pin
100 x 100 x 2.5mm
- 5938 Fixed Pin
100 x 100 x 2.5mm

304 Stainless Steel

Bearing Hinge



- 5904 Fixed Pin
100 x 75 x 3mm
- 5905 Loose Pin
100 x 75 x 3mm
- 5927 Fixed Pin
100 x 100 x 3mm

Finishes: 304SS, BLK

Rising Butt Hinge



- 5936 Left Hand
100 x 75 x 2.5mm
- 5937 Right Hand
100 x 75 x 2.5mm

Finish: 304SS

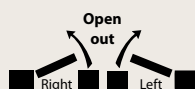

Lift Off Hinge



- 5929 Left Hand
100 x 75 x 2.5mm
- 5939 Right Hand
100 x 75 x 2.5mm

Finish: 304SS

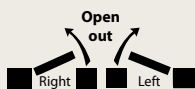

Fast Fix Bearing Hinge



- 5908 Timber Fix
100 x 70 x 2.5mm
- 5908.2 Aluminium Fix
100 x 70 x 2.5mm

Finishes: 304SS, BLK

Wide Throw Hinge



- 5909 Fixed Pin
100 x 125 x 3.5mm
- 5925 Fixed Pin
100 x 175 x 3.5mm
- 5911 Fixed Pin
100 x 150 x 3.5mm
- 5926 Fixed Pin
100 x 200 x 3.5mm

Finishes: 304SS, PB

Genie Hinges

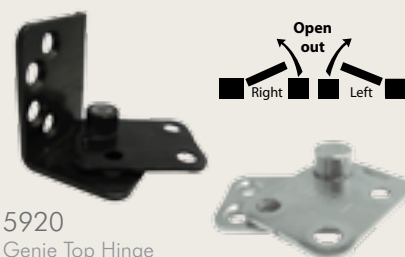

- 5920
Genie Top Hinge

- 5921
Genie Bottom Hinge

- 5922
Genie Hinge Set, includes top & bottom hinges, jig, screws & instruction

FEATURES:

- Revolutionary patented new concept
- Fit at top & bottom of door
- completely concealed
- 40% stronger than traditional hinges
- Aesthetically pleasing not visible
- 40% quicker to install, no morticing.
- 10 year warranty

Door Accessories > Bolts - Barrel Bolts

Reverse Barrel Bolts

Straight Throw

5225
150 × 31mm
9.6mm Pin
40mm throw



5226
100 × 25mm
7.6mm Pin
35mm throw



Necked

5272
125 × 31mm
5273
150 × 31mm



5270
125 × 31mm
5271
150 × 31mm



Necked
Outward
25mm Throw

Necked
Inward
25mm Throw

- Solid brass one piece extrusion
- Heavy sprung ball bearing retention
- Suitable for a large range of door types including bi-fold, sliding, hinged and rebated doors
- Other finishes available to order

Finishes: BN, CP, PB, SC

Dust Socket

5239
25 × 40mm
13mm ID



Finishes: PB, BN, SC

Security Door Bolt

1175
25mm bolt projection
Includes 100 & 75mm length keys

NEW

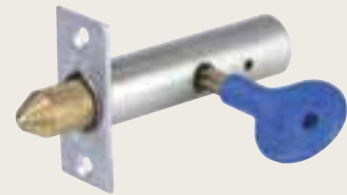

Finish: SC

Barrel Bolts

Straight



5207 50 × 25mm
20mm throw



5208 75 × 25mm
20mm throw



5209 100 × 25mm
20mm throw



5210 150 × 31mm
Long Throw (50mm) (Pic)

5224 150 × 31mm
Standard Throw (30mm)

Necked



5211
50 × 25mm
11mm throw



5212
75 × 25mm
19mm throw



5213
100 × 25mm
19mm throw



5214
150 × 31mm
25mm throw

Finishes: BN, CP, PB, SC, OF

Door Accessories > Bolts - Flush Bolts & Panic Bolts

Flush Bolts

5235 Standard Throw
152mm length x 19mm width
11mm diameter bolt
18mm throw



Solid Brass Construction
Finishes: BN, CP, PB, SC

10423 Long Throw
152mm length x 19mm width
11mm diameter bolt
24mm throw

NEW



Solid Brass Construction
Finishes: BN, CP, PB, SC

14000 Sliding Action
150mm length x 21mm width
10mm diameter bolt
25mm throw



Stainless Steel Construction
Finish: SS, PSS

5308 Heavy Duty Cam Action
150mm length x 25mm width
12.5mm diameter bolt
18.5mm throw



Solid Brass Construction
Finishes: BN, SC

Panic Bolts



Straight
10404 - 250mm
10405 - 300mm
10406 - 450mm
10407 - 600mm

Necked
10408 - 250mm
10409 - 300mm
10410 - 450mm
10411 - 600mm

Extra Saddles
10429



Finish: SS



76

ZANDA
ARCHITECTURAL HARDWARE

Insist on Quality & Style
Insist on Zanda Accessories.

Door Accessories > Wardrobe Accessories

Wardrobe Options

Lever Option
With dummy fixing mount.

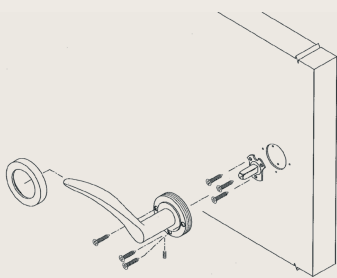

Dummy Handle Fixing Mounts

1152 8mm Spindle
32mm diameter



1137 7.6mm Spindle
26mm diameter



10687 8mm Spindle
60mm length
65mm diameter

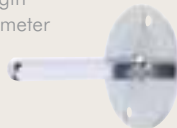

Finish: CP

Cabinet Pull Options

Use with one of the catches adjacent or below. Through door rear fix from the back.

See pages 101-115 for Cabinet Handles



Double Ball Catches

5015
50 x 9mm

5016
60 x 11mm



Finishes: PB, SC
Solid Brass Construction

Adjustable Roller Catch

1119
Faceplate: 58 x 23mm
35mm depth
19mm diameter



Finishes: CP, PB

Door Magnets

1180 25 diameter

- Can be used as a substitute for a catch
- Now countersunk for a flush finish
- Larger 25mm diameter for greater pull
- Sold as a pair and all kits include a bumpstop to reduce closing noise and for a soft close

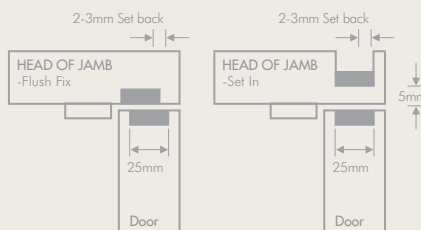

1191 Forstener Drillbit
25mm

- Use with Zanda 1180 magnets
- Drills a smooth clean hole
- 25mm diameter 9.5mm shank
- The short narrow point won't protrude into jamb like a standard spade bit (as shown left, giving you greater screw fixing).

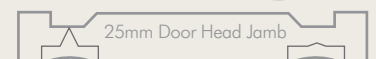

Standard 25mm spade bit
Zanda 1191 Forstener bit

Door Accessories > Escutcheons, Knockers & Miscellaneous

Escutcheons

Euro
7020 E
55 x 11mm



Finishes: BN, SC, TG

Euro
8102 E
55 x 11mm plate



Finishes: BN, SC, BLK

Euro
8146 E
60 x 30mm

NEW



Finishes: BN, SC

Euro
8003 E
45 x 10mm



Finishes: BN, PB, SC, BLK

Oval
7020 O
55 x 11mm



Finishes: BN, SC, TG

Oval
8102 O
55 x 11mm plate



Finishes: BN, SC

Euro
8140 E
51 x 10mm

NEW



Finishes: BN, SC

Oval
8003 O
45 x 10mm



Finishes: BN, SC

Blank
7056
55 x 11mm



Finishes: BN, SC, TG

Blank
8136
55 x 11mm plate



Finishes: BN, SC

Euro
10062
56 x 10mm

NEW



Finishes: BN/CP (Two Toned)

Euro
2034
58 x 37mm



Finish: BLK

Knockers

3034
210 x 95mm

Finishes: PB, SC



5024
200 x 50mm

Finishes: PB, SC



Miscellaneous

1166
Split Spindle
8 x 98mm

1167
Split Spindle
7.6 x 98mm

1171
Split Spindle
7.6mm x 116mm
for 52mm plus doors



1141 Round Adaptor
Plate 65mm
(Sold in pairs)

1168 Square Adaptor
Plate 65 x 65mm
(Sold in pairs)



Finishes: SS, PB, OF

Door Accessories > Privacy Hardware

Privacy Hardware

7032



52.5mm Roses
60mm B/S Bolt
6mm Spindle

7076
Indicator



7071
Turn and Escape
only (Pic)



7072 Kit
including 60mm
B/S Bolt
55mm Roses
5mm Spindle

Finishes: BN, SC

10415
Indicator Bolt

NEW



Finishes: SC

8089

45mm Rose
60mm B/S Bolt
5mm Spindle



Finishes: PB, SC

8101

60mm B/S Bolt
5mm Spindle
55mm Plate



8113

Privacy Turn
with Tailbar
55mm Plate



7067

Privacy Turn with Tailbar
55mm Rose



Finishes: BN, SC

8104

Privacy Turn with Tailbar
45mm Rose

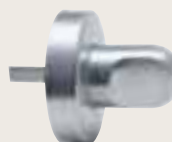

Finishes: PB, SC

8118

Double turn set on 46mm rose Ø
c/w 8mm Spindle



Finishes: BN, SC

8016

Turn and Escape
45mm Rose, 5mm Spindle



Finishes: SC, PB

8055

5mm Spindle



Finishes: BN, SC, PB

8117

Double turn set on 55mm square
rose c/w 8mm Spindle



Finishes: BN, SC

8139

Double turn set on 51mm
square rose c/w 8mm Spindle

NEW



Finishes: BN, SC

8147

Double turn set on
60 x 30mm
Slimline Plates c/w
8mm Spindle

NEW



Finishes: BN, SC



See page
119 for
Privacy Bolts

Door Accessories > Hooks & Bannister Brackets

Aluminium Hooks



Cabin Hooks

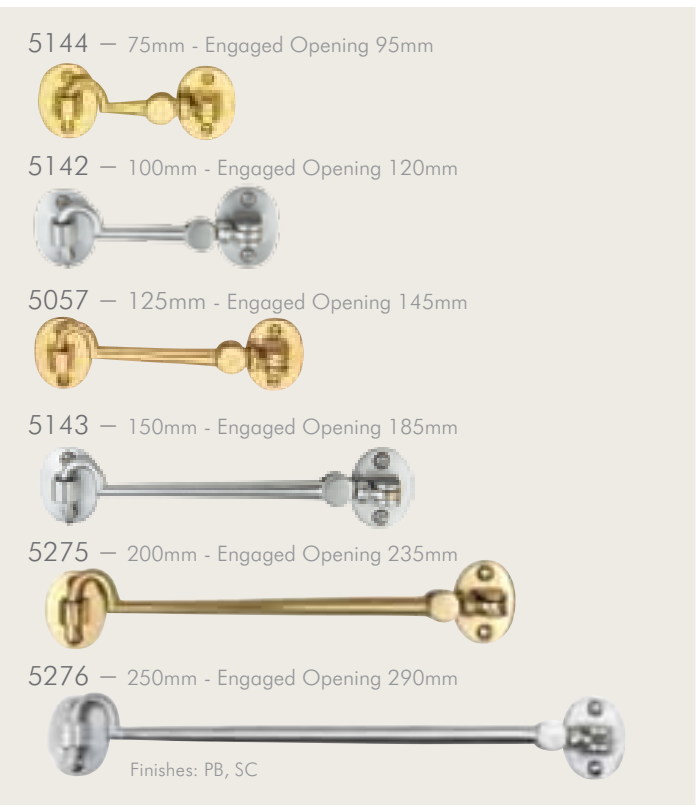

Bannister Brackets



Door Viewer



*Discontinued, limited stocks available

DOOR CONTROLS



Rutland is a manufacturer of high quality and efficient door closers and controls. Based in England, Rutland distributes through a network of dealers throughout UK, Europe & USA. Zanda Architectural exclusively distributes a select collection of Rutland door controls suited for the rigours of Australian conditions and standards. Through continual investment we are not only improving our products in their ability, design, performance and reliability, but also through innovation our products have become faster and easier to fit making them the first in demand and specification. From Buckingham Palace to the largest shopping center in Europe, Rutland products feature on millions of doors worldwide. In fact, a Rutland door closer is currently sold every 31.57 seconds.



82

ZANDA
ARCHITECTURAL HARDWARE

R
RUTLAND



Beyond Expectation

Door Controls > Rutland Door Controls - Contract Closer

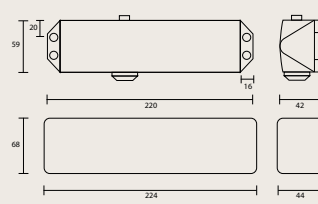

TS.3204 Contract Closer

FEATURES:

- 10 year guarantee
- Power Size EN3
- Adjustable closing speed
- Adjustable Latch Action
- Max Door Width: 930mm
- Max Door Weight: 60kg
- Opening Angle: 180°
- Non handed

TS.3204 Kits



TS.3204.FB
- Standard Unit, includes closer, flat bar armset and PA bracket

Finishes: SE & GE



TS.3204.SLFB
- Combined Unit, includes closer, flat bar armset, cover and PA bracket

Finishes: SE, SNP, EB & OF



TS.3204BC.SLFB
- Combined Unit, includes closer, flat bar armset, cover, PA bracket with BACK CHECK

Finishes: SE, SNP, EB & OF

TS.3204 Components



TS.3204 - Mechanism only
TS.3204BC - Mechanism only with BACK CHECK

Finishes: SE & GE



FBA.1 - Flat bar armset (Includes PA bracket and fixings)

Finishes: SE, SNP, EB & OF

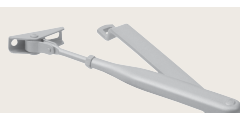

STA.1 Screw type armset (Includes PA bracket and fixings)

Finish: SE



HOA.1 - Hold open armset (Includes PA bracket and fixings)

Finish: SE



SL.34 - Cover only

Finishes: SE, SNP, EB & OF



PAB.1 - Parallel Arm (PA) Bracket

Finishes: SE, GE, SNP & EB



DP.34 Drop Plate

Finish: SE



SP.1 - Shoe Plate

Finish: SE



HDF.34 - Hollow door fixing pack

Finish: SE

84

ZANDA
ARCHITECTURAL HARDWARE



Door Controls > Rutland Door Controls - Architectural Closers



TS.9204 Architectural Closer

Available in Marine Grade 316 SS

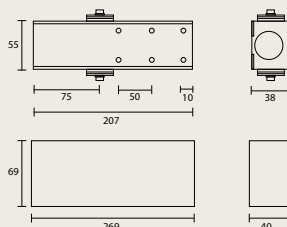

FEATURES:

- 25 Year Guarantee
- Power Size EN2-4 (Adjustable by position)
- Adjustable Closing Speed
- Adjustable Latch Speed
- Adjustable Back Check (Optional)
- Max Door Width: 1100mm (EN4)
- Max Door Weight: 80kg (EN4)
- Opening Angle: 180°
- Non handed

TS.9204 Kits



TS.9204.FB
- Standard unit, includes flat bar armset, closer and PA Bracket

Finishes: SE



TS.9204.SRFB
- Combined unit, includes flat bar armset, semi-radius cover, closer & PA Bracket

Finishes: SE, SNP, EB, 316SS, CP & OF



TS.9204BC.FB
- Standard unit, includes flat bar armset, closer, PA Bracket & BACK CHECK

Finishes: SE



TS.9204BC.SRFB
- Combined unit, includes flat bar armset, semi-radius cover, closer, PA Bracket & BACK CHECK

Finishes: SE, SNP, EB, 316SS, CP & OF

TS.9204 Components



TS.9204 - Mechanism only
TS.9204BC - Mechanism only with BACK CHECK

Finishes: SE



FBA.1 - Flat bar armset
(Includes PA bracket and fixings)

Finishes: SE, SNP, PNP, EB, 316SS



STA.2 - Screw type armset
(Includes PA bracket and fixings)

Finishes: SE



HOA.2 - Hold open armset
(Includes PA bracket and fixings)

Finishes: SE



SR.90 - Semi-radius Cover

Finishes: SE, SNP, PNP, EB, 316SS



SQ.90 - Square Cover

Finishes: SE, SNP, EB, SS, PSS

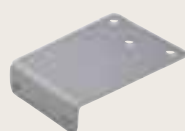

PAB.1 - Parallel Arm Bracket

Finishes: SE, GE, SNP & EB



DP.90 - Drop Plate

Finishes: SE, SNP & EB



SR.1 - Shoe Plate

Finishes: SE

86

ZANDA
ARCHITECTURAL SOLUTIONS



Project: Holiday Inn Express Hotel
Product: TS.9205.SRSA.SNP



Door Controls > Rutland Door Controls - Architectural Closers



TS.9205 Architectural Closer

Available in Marine Grade 316 SS

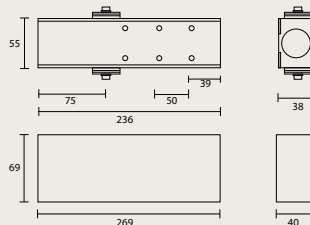

FEATURES:

- 35 Year Guarantee
- Power Size EN2-5 (Adjustable by spring)
- Adjustable Closing Speed
- Adjustable Latch Speed
- Opening Angle: 180°
- Adjustable Back Check
- Adjustable Delayed Action
- Max Door Width: 1250mm (EN5)
- Max Door Weight: 110kg (EN5)
- Non Handed

TS.9205 Kits



TS.9205.FB
- Standard unit, includes flat bar armset, closer and PA Bracket
Finishes: SE



TS.9205.SRFB
- Combined unit, includes flat bar armset, semi-radius cover, closer & PA Bracket
Finishes: SE, SNP, EB, 316SS, CP & OF



TS.9205.SA
- Standard slide arm unit, includes slide armset & closer
Finishes: SE



TS.9205.SRSA
- Combined slide arm unit, includes slide armset, semi-radius cover & closer
Finishes: SE, SNP, EB, 316SS, CP & OF

TS.9205 Components



TS9205 - Mechanism only
Finishes: SE



SA.1 - Slide Armset (Includes connector bar and fixings)
Finishes: SE, SNP & EB



FBA.1 - Flat bar armset (Includes PA bracket and fixings)
Finishes: SE, SNP, EB & 316SS



STA.2 - Screw type armset (Includes PA bracket and fixings)
Finishes: SE



HOA.2 - Hold open armset (Includes PA bracket and fixings)
Finishes: SE



SR.90 - Semi-radius Cover
Finishes: SE, SNP, EB & 316SS



SQ.90 - Square Cover
Finishes: SE, SNP, EB & 316SS



PAB.1 - Parallel Arm Bracket
Finishes: SE, GE, SNP & EB



DP.95 - Drop Plate
Finishes: SE, SNP & EB



SP.1 - Shoe Plate
Finishes: SE

88

ZANDA
ARCHITECTURAL HARDWARE



Door Controls > Rutland Door Controls - Architectural Closers



TS.9206 Architectural Closer

Available in Marine Grade 316 SS

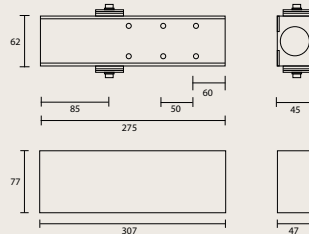

FEATURES:

- 25 Year Guarantee
- Power Size EN2-6 (Adjustable by spring)
- Adjustable Closing Speed
- Adjustable Latch Speed
- Adjustable Back Check
- Adjustable Delayed Action
- Max Door Width: 1400mm (EN6)
- Max Door Weight: 120kg (EN6)
- Opening Angle: 180°
- Non Handed

TS.9206 Kits



TS.9206.FB
- Standard unit, includes flat bar armset, closer and PA Bracket

Finishes: SE



TS.9206.SRFB
- Combined unit, includes flat bar armset, semi-radius cover, closer & PA Bracket

Finishes: SE, SNP, EB, 316SS, & OF



TS.9206.SA
- Standard slide arm unit, includes slide armset & closer

Finishes: SE



TS.9206.SRSA
- Combined slide arm unit, includes slide armset, semi-radius cover & closer

Finishes: SE, SNP, EB, 316SS, & OF

TS.9206 Components



TS.9206 - Mechanism only

Finishes: SE



SA.1 - Slide Armset (Includes connector bar and fixings)

Finishes: SE, SNP & EB



FBA.3 - Flat bar armset (Includes PA bracket and fixings)

Finishes: SE, SNP, EB & 316SS

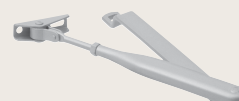

STA.3 - Screw type armset (Includes PA bracket and fixings)

Finishes: SE



HOA.2 - Hold open armset (Includes PA bracket and fixings)

Finishes: SE



SR.96 - Semi-radius Cover

Finishes: SE, SNP, EB & 316SS



PAB.1 - Parallel Arm Bracket

Finishes: SE, GE, SNP & EB



AB.1 - Architrave Bracket

Finishes: SE, GE, SNP & EB



DP.96 - Drop Plate

Finishes: SE, SNP & EB



SR.1 - Shoe Plate

Finishes: SE



TS.10106 Extreme Door Closer

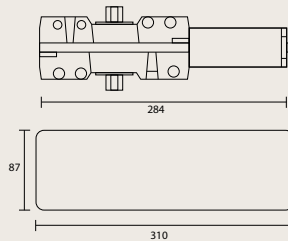

FEATURES:

- 25 Year Guarantee
- UL listed to 2 million cycles
- Power Size EN1-6 (Adjustable by spring)
- Adjustable Closing Speed
- Adjustable Latch Speed
- Max Door Width: 1400mm
- Max Door Weight: 120kg
- Non handed



Our most durable &
TOUGHEST
Closer Yet!

Manufactured to withstand
the most demanding
circumstances.

TS.10106 Kit



TS.10106.FB4SL
- Heavy Duty Door Closer
body (including back
check & delayed action),
cover & armset.

Must specify handing
(LH or RH)

Finishes: SE & SNP

TS.10106 Components



TS.10106 - Mechanism only

Finishes: SE



SL.106 - Cover to suit TS10106

Finishes: SE & SNP



HOA.106 - Mechanism only

Finishes: SE & SNP



CSA.106 - Cushion Stop Armset

Finishes: SE & SNP



TS.11204 High Performance Cam Action Closer

FEATURES:

- 10 Year Guarantee
- Power Size EN2-4 (Adjustable by spring)
- Cam Action Mechanism
- Adjustable Closing Speed
- Adjustable Latch Speed
- Max Door Width: 1100mm
- Max Door Weight: 80kg
- Opening Angle: 120°
- Non handed

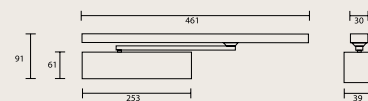
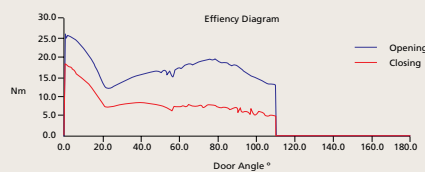

TS.11204 Kit



TS.11204 Components

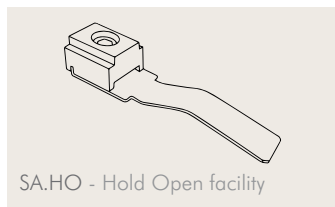
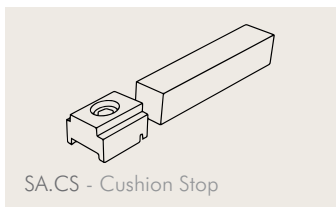

92

ZANDA
ARCHITECTURAL HARDWARE

Project: St Bernard's Hospital
Product: ITS.11204.SE





ITS.11204 Concealed Cam Action Closer

FEATURES:

- 10 Year Guarantee
- Minimum Door Thickness 44mm
- Power Size EN2-4 (Adjustable by spring)
- Cam Action Mechanism
- Adjustable Closing Speed
- Adjustable Latch Speed
- Max Door Width: 1100mm
- Max Door Weight: 80kg
- Opening Angle: 120°
- Non handed

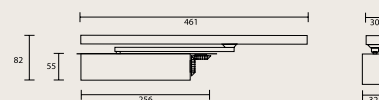
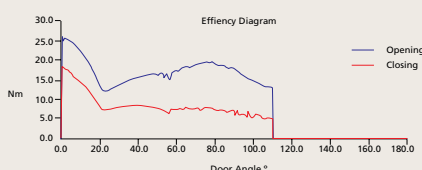

ITS.11204 Kits



ITS.11204.DAX - DOUBLE ACTION
Combined Unit, includes mechanism & ITS-B rail & connector bar
Finishes: SE



ITS.11204.SAX - SINGLE ACTION
Combined Unit, includes mechanism & ITS-B rail & connector bar
Finishes: SE

ITS.11204 Components



ITS.11204.SE - Mechanism only
Finishes: SE



SA.2.DAX - Double Action Slide Arm Connector Bar
SA.2.SAX - Single Action Slide Arm Connector Bar
Finishes: SE

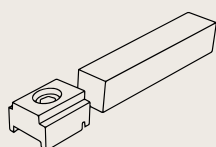

SA.CS - Cushion Stop

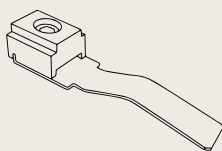

SA.HO - Hold Open facility



94

ZANDA
ARCHITECTURAL HARDWARE



Door Controls > Rutland Door Controls - Floor Springs



TS.7000 Floor Springs

Marine Grade 316 SS

FEATURES:

- 10 Year Guarantee
- Power Size EN2, 3, 4
- Adjustable Closing Speed
- Adjustable Latch Speed
- Back Check
- Opening Angle: 130°
- Non handed

Power Size	Max Weight	Max Width
EN2	70kg	850mm
EN3	105kg	950mm
EN4	150kg	1200mm

TS.7000 Kits

<p>Hold Open - Double Action TS7002.HO.DAX - EN2 TS7003.HO.DAX - EN3 TS7004.HO.DAX - EN4 Finishes: 316SS, PB & OF</p>	<p>Hold Open - Single Action TS7002.HO.SAX - EN2 TS7003.HO.SAX - EN3 TS7004.HO.SAX - EN4 Finishes: 316SS, PB & OF Handing must be specified (LH or RH)</p>	<p>Non Hold Open - Double Action TS7002.NHO.DAX - EN2 TS7003.NHO.DAX - EN3 TS7004.NHO.DAX - EN4 Finishes: 316SS, PB & OF</p>	<p>Non Hold Open - Single Action TS7002.NHO.SAX - EN2 TS7003.NHO.SAX - EN3 TS7004.NHO.SAX - EN4 Finishes: 316SS, PB & OF Handing must be specified (LH or RH)</p>
---	--	--	---

TS.7000 Components

<p>PS.170L - Single Action Accessory Pack (LH) PS.170R - Single Action Accessory Pack (RH) Finishes: SS & PB</p>	<p>PS.180 - Double Action Accessory Pack Finishes: SS & PB</p>	<p>CP.70 - Cover Plate only Finishes: 316SS & PB</p>	<p>Spindle Extensions</p> <ul style="list-style-type: none"> ES.70.3 - 3mm ES.70.5 - 5mm ES.70.8 - 8mm ES.70.10 - 10mm ES.70.13 - 13mm ES.70.15 - 15mm ES.70.18 - 18mm ES.70.23 - 23mm ES.70.48 - 48mm
<p>HMC.70 Hollow floor mounting cradle (108W x 306L x 40H) Finishes: BLK</p>	<p>DF.70 Dummy Floor Spring (non mechanical) Finishes: 316SS & PB</p>		



TS.8000 Transom Closers

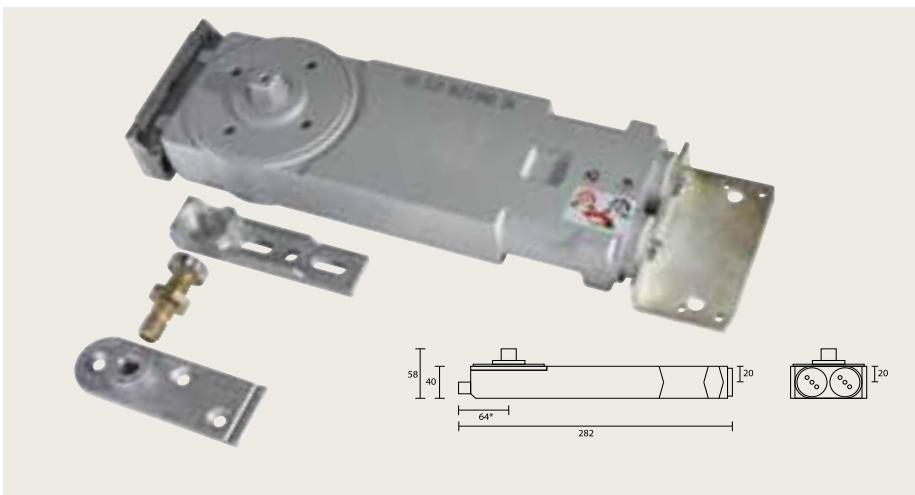

FEATURES:

- 10 Year Guarantee
- Power Size EN2, 3, 4
- Adjustable Closing Speed
- Adjustable Latch Speed
- Opening Angle: 130°
- Non handed
- Suits metal or timber doors

Power Size	Max Weight	Max Width
EN2	70kg	850mm
EN3	105kg	950mm
EN4	150kg	1100mm

TS.8000 Kits

<p>Hold Open with End Load Armset</p>  <p>TS8002.HO.ELA - EN2 TS8003.HO.ELA - EN3 TS8004.HO.ELA - EN4</p>	<p>Hold Open with Side Load Armset</p>  <p>TS8002.HO.SLA - EN2 TS8003.HO.SLA - EN3 TS8004.HO.SLA - EN4</p>	<p>Hold Open with Short Side Load Armset</p>  <p>TS8002.HO.SSLA - EN2 TS8003.HO.SSLA - EN3 TS8004.HO.SSLA - EN4</p>
<p>Non Hold Open with End Load Armset</p>  <p>TS8002.NHO.ELA - EN2 TS8003.NHO.ELA - EN3 TS8004.NHO.ELA - EN4</p>	<p>Non Hold Open with Side Load Armset</p>  <p>TS8002.NHO.SLA - EN2 TS8003.NHO.SLA - EN3 TS8004.NHO.SLA - EN4</p>	<p>Non Hold Open with Short Side Load Armset</p>  <p>TS8002.NHO.SSLA - EN2 TS8003.NHO.SSLA - EN3 TS8004.NHO.SSLA - EN4</p>

TS.8000 Components

<p>ELA.80 - End Load Arm</p> 	<p>SLA.80 - Side Load Arm</p> 	<p>SSLA.80 - Short Side Load Arm</p> 	<p>DT.80 - Dummy Body (non mechanical)</p> 
--	---	---	--

Door Controls > Rutland Door Controls - Pivots & Stops



Pivots

PS.170L - Single Action Accessory Pack (Left Hand)
PS.170R - Single Action Accessory Pack (Right Hand)

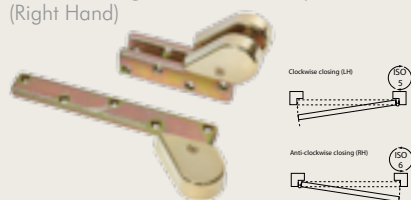

Finishes: SS & PB

PS.180 - Double Action Accessory Pack

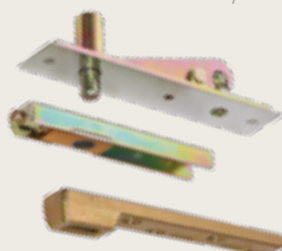

Finishes: SS & PB

PS.210 - Retractable top centre pivot with cover plate and bottom strap (15mmØ)

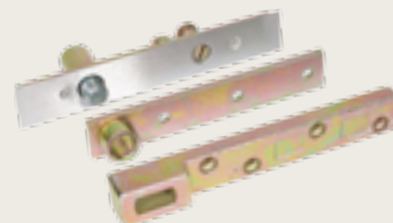

Finishes: SS

PS.110 - Pivot set with adjustable top centre, bottom strap and door frame fixing bracket (12mmØ)

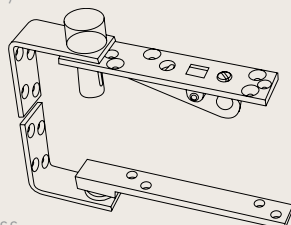

Finishes: SS

PS.260 - Floor Mount Spindle Bearing



Finishes: SS

PS.240 - Fixed Top Centre Pivot (15mmØ)



Finishes: SS

Emergency Release Door Stop



TH.107 - LOCK IN & OUT

FEATURES:

- Use in conjunction with a pivot set
- Allows double action door to operate as single swing, when hung on pivot doors
- Emergency access is gained by depressing the stop and pulling the door outward.
- Includes hold back facility
- Stop release resets automatically
- Maintenance free - 10 year warranty
- 304 Grade Stainless Steel



Door Controls > Genie Door Controls

Genie Door Controls

G555

FEATURES:

- Completely concealed into either jamb or top of door
- Extremely smooth and efficient operation and extremely easy to open and close—ideal for the elderly or less abled
- Tested to 300,000 cycles
- Adjustable speed
- Hold open at 90 degrees, opening angle 180 degrees
- 100kg weight rating
- Minimum door thickness 45mm (if installing closer into door, not jamb)
- Unit comes complete with slide arm and fixings

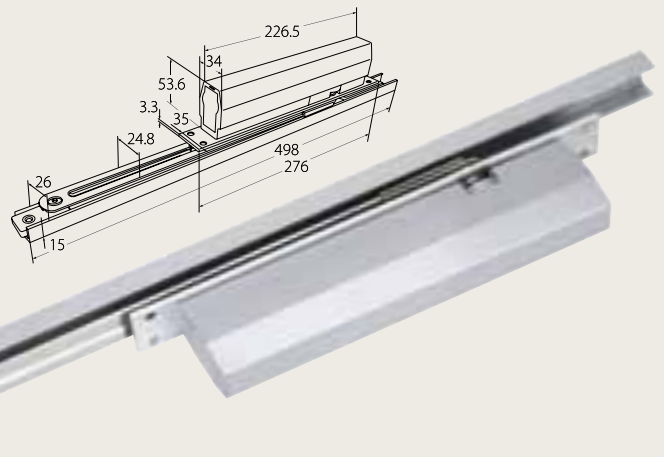

G500

Concealed closer
includes hydraulic power unit,
top pivot fixing bolts & screws



FEATURES:

- Revolutionary patented new concept
- Pivots at top & bottom of door
- completely concealed
- Torque & speed adjustments
- Pivots both ways
- Hold open at 90°
- 10 year warranty
- Rated 80kgs

G5 Glass Door Pivot Fittings

G5.1 (Glass to Glass—pictured)
G5.2 (Wall Fitting to Glass)

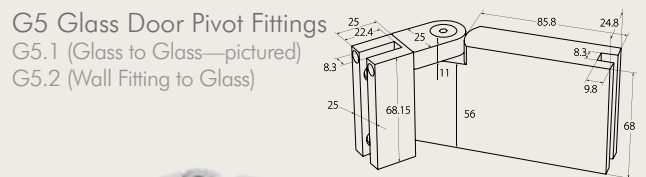

Bottom Pivot

Top Pivot

FEATURES:

- Pivots at top and bottom, looks very neat
- Revolutionary new concept which replaces conventional glass pivot closers
- Good for child finger protection
- Auto closing and always returns to the exact closed position
- 50kg weight rating
- Efficient and very easy to open

LETTERBOX HARDWARE



Zanda's range of numerals are manufactured from solid brass material, then electroplated offering maximum durability against rust and harsh weather conditions. Supplied complete with fixings they are easily attached to fences, walls or directly onto your mailbox.

Zanda's new range of mailboxes are designed to be both modern and functional. Each design incorporates a solid structure and exceptional attention to detail, resulting in a product of very high quality.



100 Numerals & Alphabets
100 Mailboxes

Numerals & Alphabets

5251 50mm
5253 100mm
5254 150mm
5255 200mm



Available in
Retail Display Packs



Victorian Style

5055 76mm



5013 50mm
5014 76mm



5244 150mm



Finishes: PB, SC, BLK

Mailboxes



12500 Eclipse
500 (h) x 340 (w) x 200mm (d)
Finishes: SS, White



12502 Frontier
440 (h) x 345 (w) x 180mm (d)
Finishes: SS, BLK, White, Copper



12505 Classic
360 (h) x 360 (w) x 150mm (d)
Finishes: SS, White



12520 Stand
Suits all three mailboxes
Finishes: SS, Black

CABINET HANDLES



- 102 Designer Handles
- 113 Aluminium Designer Handles
- 114 Designer Knobs
- 115 Economy Handles
- 116 Extrusions

Abbreviations

- CRS = Screw/Bolt Centres
- O/A = Overall Length
- W = Width
- P = Projection
- D = Diameter
- R/R = Recess Required

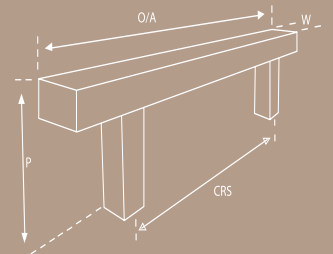

NEW

Toorak

Finishes: BN & CP

DUE NOVEMBER 2015

Code	CRS	O/A	W	P
16050	128mm	139mm	11mm	32mm
16051	160mm	171mm	11mm	32mm
16052	192mm	203mm	11mm	32mm
16054	288mm	299mm	11mm	32mm
16057	416mm	427mm	11mm	32mm
16059	608mm	619mm	11mm	32mm



Mosman

Finishes: BN & CP

Code	CRS	O/A	W	P
16030	128mm	142mm	7mm	35mm
16031	160mm	174mm	7mm	35mm
16032	224mm	238mm	7mm	35mm



Tavola

Finishes: BN, OF



Code	CRS	O/A	W	P
6425	64mm	136mm	50mm	22mm

Plato

Finishes: BN, OF



Code	CRS	O/A	W	P
6424	32mm	70mm	70mm	22mm

Cabinet Handles > Designer Handles

Pakello

Finishes: BN, OF

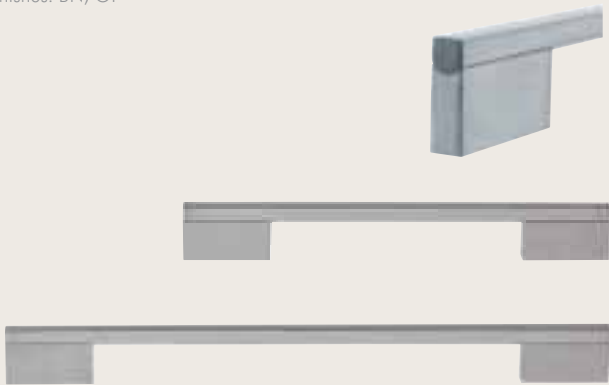

Code	CRS	O/A	W	P
6434	128mm	177mm	10mm	32mm
6435	160mm	209mm	10mm	32mm
6436	192mm	241mm	10mm	32mm
6437	288mm	337mm	10mm	32mm
6438	448mm	497mm	10mm	32mm
6439	640mm	689mm	10mm	32mm



Monza

Finishes: BN, OF

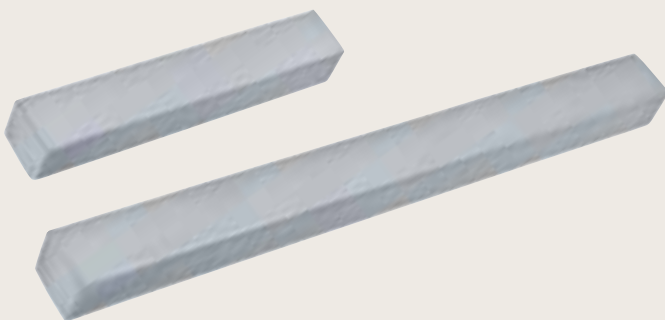

Code	CRS	O/A	W	P
6432	160mm	167mm	23mm	26mm
6433	320mm	327mm	23mm	26mm



Cabinet Handles > Designer Handles

Melo

Finishes: BN, OF

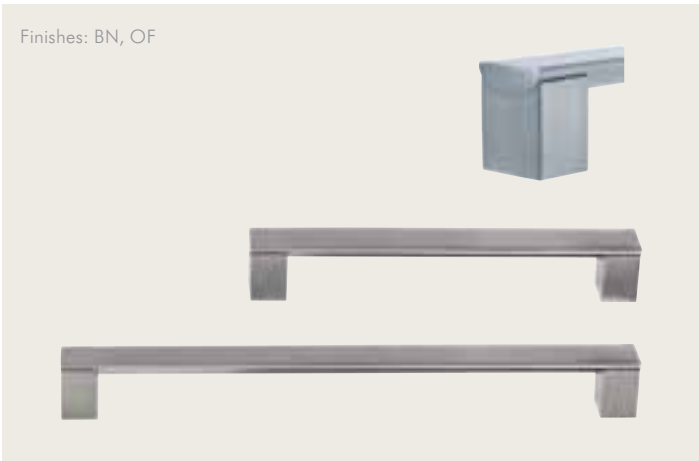

Code	CRS	O/A	W	P
6426	128mm	144mm	25mm	32mm
6427	160mm	176mm	25mm	32mm
6428	192mm	208mm	25mm	32mm
6429	288mm	304mm	25mm	32mm
6430	448mm	464mm	25mm	32mm
6431	640mm	656mm	25mm	32mm



Prado

Finishes: BLN & SC

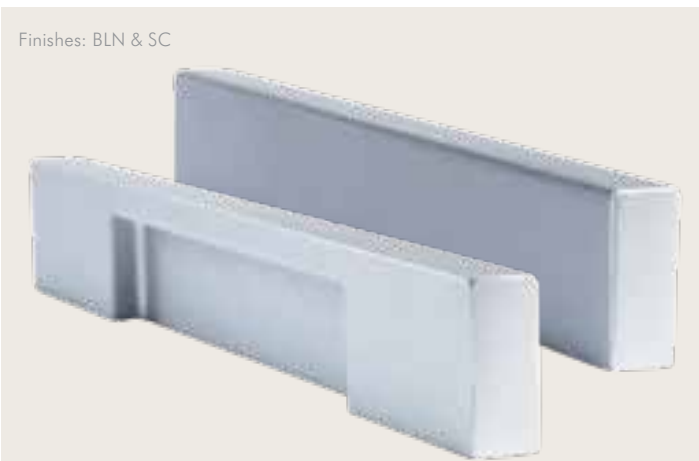

Code	CRS	O/A	W	P
6383	96mm	150mm	8.5mm	20mm



Cabinet Handles > Designer Handles

Quadra

Finishes: BN & OF

Code	CRS	O/A	W	P
16000	64mm	78mm	25mm	21mm
16001	96mm	110mm	25mm	21mm
16002	128mm	142mm	25mm	21mm
16003	160mm	174mm	25mm	21mm
16004	192mm	206mm	25mm	21mm
16005	224mm	238mm	25mm	21mm



Milan

Finishes: BN & OF

Code	CRS	O/A	W	P
16006	128mm	178mm	9mm	30mm
16007	160mm	210mm	9mm	30mm
16008	192mm	242mm	9mm	30mm
16015	288mm	338mm	9mm	30mm
16016	448mm	498mm	9mm	30mm
16017	640mm	690mm	9mm	30mm



Melange

Finishes: BN & OF

Code	CRS	O/A	W	P
16009	64mm	104mm	8mm	33mm
16010	96mm	136mm	8mm	33mm
16011	128mm	168mm	8mm	33mm
16012	160mm	200mm	8mm	33mm
16013	192mm	232mm	8mm	33mm
16014	224mm	264mm	8mm	33mm



106

 ZANDA
ARCHITECTURAL HARDWARE



Cabinet Handles > Designer Handles

Minerva

Finishes: BN & SA

Code	CRS	O/A	W	P
6413	96mm	126mm	15.5mm	36mm
6314	128mm	158mm	15.5mm	36mm
6414	160mm	190mm	15.5mm	36mm
6315	192mm	222mm	15.5mm	36mm
6316	288mm	318mm	15.5mm	36mm
16026	320mm	350mm	15.5mm	36mm
6415	448mm	478mm	15.5mm	36mm
16025	544mm	574mm	15.5mm	36mm

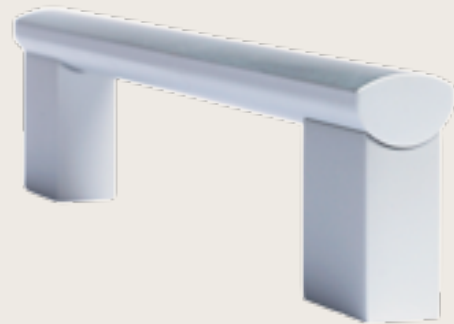

Loreto

Finishes: BN/SS

Code	CRS	O/A	W	P
6074	128mm	148mm	10mm	38mm
6075	192mm	212mm	10mm	38mm
6076	320mm	340mm	10mm	38mm
6392	448mm	468mm	10mm	38mm
6393	544mm	564mm	10mm	38mm
6394	640mm	660mm	10mm	38mm
6395	704mm	724mm	10mm	38mm



Polo

Finishes: BN & SC

Code	CRS	O/A	W	P
6333	128mm	158mm	19mm	24mm
6334	160mm	192mm	21mm	24mm
6335	192mm	226mm	24mm	24mm



Cabinet Handles > Designer Handles

Dalkeith

Finishes: BN & SC



Code	CRS	O/A	W	P
6108	160mm	193mm	21mm	34mm

Elro

Finishes: BN & SC



Code	CRS	O/A	W	P
6385*	192mm	200mm	22.5mm	20.5mm

Mondo

Finishes: BN & SC



Code	CRS	O/A	W	P
6386	192mm	200mm	35mm	26mm

Cabinet Handles > Designer Handles

Monato

Finish:
Bar- Stainless Steel
Legs- Brushed Nickel

Code	CRS	O/A	W	P
6324	128mm	143mm	15mm	35mm
6325	160mm	175mm	15mm	35mm
6326	224mm	239mm	15mm	35mm
6327	320mm	335mm	15mm	35mm

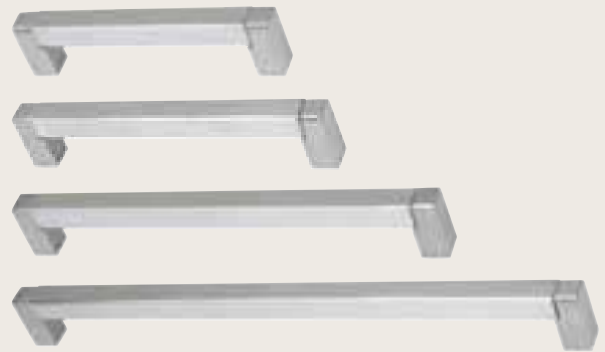

Sincro

Finishes: BN & SC

Code	CRS	O/A	W	P
6067*	64mm	72mm	12mm	27mm
6068	96mm	104mm	12mm	27mm
6069	128mm	136mm	12mm	27mm
6396	160mm	168mm	12mm	27mm
6397	192mm	200mm	12mm	27mm
6398	288mm	296mm	12mm	27mm
6399	448mm	456mm	12mm	27mm



Mitred D Pull

Finish: SS

Code	CRS	O/A	W	P
6071	96mm	108mm	12mm	30mm
6072	160mm	172mm	12mm	30mm
6073	288mm	300mm	12mm	30mm
6387	320mm	332mm	12mm	30mm
6388	448mm	460mm	12mm	30mm
6389	544mm	556mm	12mm	30mm
6390	640mm	652mm	12mm	30mm
6391	704mm	716mm	12mm	30mm



110

ZANDA
ARCHITECTURAL HARDWARE



Project: City Square - Perth
Product: 6340 Marco Handle



Cabinet Handles > Designer Handles

Marco

Finish: BN & SC

Code	CRS	O/A	W	P
6336	96mm	122mm	8mm	26mm
6337	128mm	157mm	8mm	26mm
6338	160mm	193mm	8mm	26mm
6339	192mm	225mm	8mm	26mm
6340	240mm	273mm	8mm	26mm
6382	320mm	356mm	8mm	28mm



Marco Nero

Finish: BLK

Code	CRS	O/A	W	P
6336	96mm	122mm	8mm	26mm
6337	128mm	157mm	8mm	26mm
6338	160mm	193mm	8mm	26mm
6339	192mm	225mm	8mm	26mm
6382	320mm	356mm	8mm	28mm



Cabinet Handles > Designer Handles

Recessed Handles

Finish: BN



Code	CRS	O/A	R/R
6110	128mm	153mm	11mm

Metro

Finish: BN



Code	CRS	O/A	W	P
6351*	128mm	168mm	10mm	35.5mm
6352*	160mm	200mm	10mm	35.5mm
6353*	192mm	232mm	10mm	35.5mm
6354*	288mm	328mm	10mm	35.5mm
6355*	448mm	488mm	10mm	35.5mm

Rialto

Finishes: BN & SC



Code	CRS	O/A	W	P
6341	16mm	39mm	21mm	19.5mm

Anglo

Finishes: BN & SC



Code	CRS	O/A	W	P
6345	16mm	25mm	25mm	20.5mm

Tezo

Finishes: BN & SC



Code	CRS	O/A	W	P
6384	32mm	40mm	10mm	20mm

*Discontinued, limited stocks available

Cabinet Handles > Designer Handles - Aluminium

Roseto



Finish: SA

Code	CRS	O/A	W	P
6082	32mm	45mm	8mm	20.5mm
6083	96mm	120mm	8mm	20.5mm
6084	192mm	230mm	8mm	20.5mm

Verbano

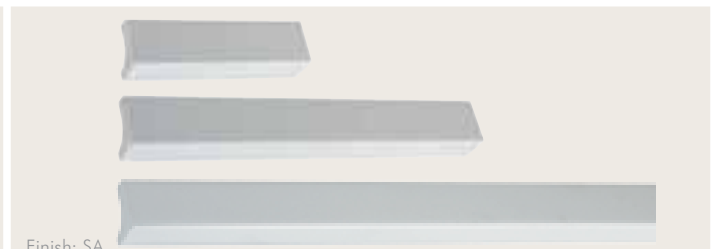

Finish: SA

Code	CRS	O/A	W	P
6328*	64mm	80mm	15mm	20mm
6086*	128mm	160mm	15mm	20mm
6329*	288mm	360mm	15mm	20mm

Sebino



Finish: SA

Code	CRS	O/A	W	P
6079*	64mm	84mm	12mm	24mm
6080*	128mm	148mm	12mm	24mm

Mimosa



Finish: SA

Code	CRS	O/A	W	P
6322	224mm	234mm	16mm	43mm
6323	288mm	298mm	16mm	43mm



*Discontinued, limited stocks available

Cabinet Handles > Designer Knobs



Ball Knob

Finish: BN



Code	D	P
6064	30mm	32.5mm

Cone Knob

Finish: BN & SC



Code	D	P
6061	22mm	20.5mm
6062	28mm	26mm

Lip Pull

Finish: BN



Code	O/A	W	P
6149	19mm	52mm	18mm

Button Knob

Finish: BN



Code	D	P
6300	32mm	121mm



Crystal

Finish: CP



Code	D	P
16046	30mm	42mm

Knightsbridge

Finish: SA



Code	D	P
6087	15mm	22.5mm
6088	25mm	30.5mm

Teardrop

Finish: BN



Code	O/A	W	P
6045*	18mm	33mm	21mm

*Discontinued, limited stocks available

Cabinet Handles > Economy Handles

D-Handles

Finishes: SC, SS



Code	CRS	O/A	W	P
6520	76mm	86mm	10mm	34mm
6006	96mm	106mm	10mm	34mm
6100	128mm	138mm	10mm	34mm
6521	224mm	234mm	10mm	34mm
6522	320mm	330mm	10mm	34mm
6523	448mm	458mm	10mm	34mm
6524	512mm	522mm	10mm	34mm

Rolled

Finish: BN



Code	CRS	O/A	W	P
6041	96mm	168mm	22mm	18mm

Slimline Bow Handles

Finishes: SC, BN

Fantastic Price
Enquire Now



Code	CRS	O/A	W	P
6500	64mm	79.5mm	9mm	25mm
6501	96mm	108mm	9.5mm	25.5mm
6502	128mm	148mm	10mm	26mm
6503	160mm	181mm	10.5mm	26.5mm
6504	224mm	251mm	11mm	27mm

Bar Handles

Fantastic Price.
Enquire Now

Finishes: BN, SC, SS



Code	CRS	O/A	W	P
6517	64mm	104mm	12mm	32mm
6047	96mm	136mm	12mm	32mm
6101	128mm	168mm	12mm	32mm
6048	160mm	200mm	12mm	32mm
6055	192mm	232mm	12mm	32mm
6518	224mm	264mm	12mm	32mm
6049	288mm	328mm	12mm	32mm
6102	320mm	360mm	12mm	32mm
6519	384mm	424mm	12mm	32mm
6103	448mm	488mm	12mm	32mm
6104	544mm	584mm	12mm	32mm
6105	640mm	680mm	12mm	32mm

Bow Handles

Finish: SC

Great Deals
Available



Code	CRS	O/A	W	P
6510	96mm	120mm	10mm	30mm
6511	128mm	162mm	10mm	31mm
6512	160mm	192mm	10mm	32mm
6513	192mm	223mm	10mm	33mm
6514	224mm	273mm	10mm	34mm
6515	256mm	311mm	10mm	35mm
6516	288mm	350mm	10mm	36mm

NEW

Modena

MID MOUNT



TOP MOUNT



FEATURES:

- Rear fitting so you save time and money
- Location scribes for easy drilling
- 2500mm lengths can be quickly and easily cut to length

Top Mount:

- 6824: To suit 16mm board
- 6825: To suit 18mm board

Mid Mount:

- 6826: To suit 16mm board
- 6827: To suit 18mm board

Finishes: SA, PC



LOCKS, LATCHES & CYLINDERS



- 118 Latches
- 118 Safety Latches
- 119 Privacy Bolts
- 119 Roller Catches
- 121 Stealth Electronic Deadbolt
- 122 Roller Mortise Locks
- 123 Nightlatches
- 125 Euro Profile Mortise Locks
- 126 Mortise Deadbolts
- 126 Sliding Door Mortise Locks
- 127 Rebate Kits
- 127 Extended Strike Plates
- 128 Euro Profile Cylinders



Locks, Latches, Cylinders > Latches & Safety Latches

Latches

<p>Tubular Latch 1131 60mm backset, 25mm Ø, 84mm c/s</p>  <p>45° Short Action Plastic recess shield included for tidy installation strike</p>  <p>Finishes: BN, SC, TG, BLK, OF</p>		<p>Tubular Latch - Heavy Duty 1213 45mm backset, 67mm c/s 1172 57mm backset, 77mm c/s 1242 83mm backset, 102mm c/s</p>  <ul style="list-style-type: none"> • Soft close latch • Double sprung allowing universal handing • 25mm Ø mortice • 15 year warranty <p>Finishes: SS, PB, OF</p>
<p>Tubular Latches 1101 70mm backset, 25mm Ø, 90mm c/s</p>  <p>45° Short Action Plastic recess shield included for tidy installation strike</p> <p>Finishes: BN, SC, OF</p>	<p>1106 45mm backset, 25mm Ø, 65mm c/s 1100 57mm backset, 25mm Ø, 78mm c/s</p> <p>90° Short Action Plastic recess shield included for tidy installation strike</p>  <p>Finishes: CP, SC, PB, OF</p>	<p>Mortice Latch 1112 57mm backset 77x39mm case size</p>  <p>Finishes: SS, PB, CP</p>

Safety Latches

<p>Round 46mm Ø rose, 8mm spindle 8120 45mm bracket 8121 57mm bracket 8122 70mm bracket</p>  <p>Finishes: BN, SC, PC</p>	<p>Square 51x 51mm plate, 8mm spindle 8123 45mm bracket 8124 57mm bracket 8125 70mm bracket</p> 	<p>Slimline Safety Latch 47mm c/s 60x30mm plates 1267 Slimline Safety Latch 1268 Slimline Safety Latch- Lockabale (pic)</p>  <p>Finishes: BN, SC, PC, OF</p>	<p>Safety latches are ideal for swimming pool situations, where council regulations require a self latching gate or door. They are normally used with a door closer, see page 83-95 for our complete door closer range.</p> 
--	--	---	---

Refer to Page 127 for Rebate Kits, Extended Strikes and other lock accessories.

Locks, Latches, Cylinders > Privacy Bolts & Roller Catches

Privacy Bolts

Bathroom Lock/Latch

1110 57mm b/s, 78mm c/s
1136 45mm b/s, 65mm c/s

- For timber doors requiring turn & release functions
- Used generally with longplate furniture and privacy turn & release (see page 79)
- Deadbolt locked or unlocked by separate turn from inside
- Deadbolt can be unlocked by separate emergency release from outside
- Reversible latch bolt
- 5mm drive

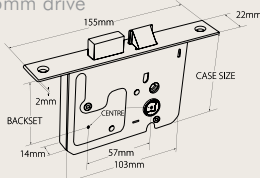

Finishes: SS, PB, OF



Heavy Duty Tubular Bolt

1173 60mm backset
5mm drive

Finishes: BN, SC, PB



Mortice Bolt

1111 57mm backset
77x39mm case size
5mm drive

Finishes: BN, SC, PB



Tubular Bolt

1120 60mm backset
5mm drive

Finishes: BN, SC, PB

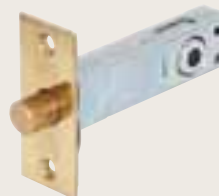

For Privacy Hardware,
see page 79



Catches

Heavy Duty Roller Bolt

1195 63 x 61mm case size

- Adjustable roller
- 15 year warranty

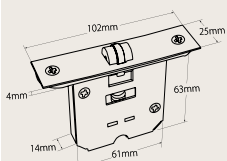

Finish: SS



Door Magnets

1180 25 diameter

- Can be used as a substitute for a catch
- Now countersunk for a flush finish
- Larger 25mm diameter for greater pull
- Sold as a pair and all kits include a bumpstop to reduce closing noise and for a soft close

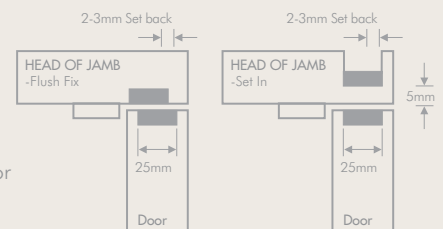

Refer to Page 127 for Rebate Kits, Extended Strikes and other lock accessories.

120

ZANDA
ARCHITECTURAL HARDWARE

Experience the
convenience of
Stealth keyless
entry



STEALTH
 ULTIMATE CONVENIENCE
 ELECTRONIC DEADBOLT LOCK

NEW

Stealth Electronic Deadbolt Lock

1317 Single Cylinder Stealth Deadbolt



- » 2 remotes, 2 keys and batteries included in kit
- » High security deadbolt with anti-saw protection to keep intruders out
- » Up to 10 different codes can be programmed including temporary contractor codes so you can control your security
- » Common C4 key profile for easy rekeying to rest of your house
- » Easy DIY installation, no wiring required
- » Long life battery power
- » Can be retrofitted over standard 55mm holes
- » Adjustable 60-70mm backset
- » Can be activated to automatically lock whenever you shut the door for added convenience
- » Can be used in conjunction with Entrance Pull Handles or a standard Passage Set
- » Comes in packaged combination kits for added convenience (see page 26)
- » Brushed Nickel designer finish

THREE EASY WAYS TO OPEN - ULTIMATE CONVENIENCE



Remote



Pin Code



Key

Roller Mortice Locks

Heavy Duty

1139 45mm backset 65mm case size
1140 57mm backset 76mm case size

- Roller bolt operated by push or pull from either side
- Lifetime Warranty on the mechanism and finish - great quality and ultra heavy duty

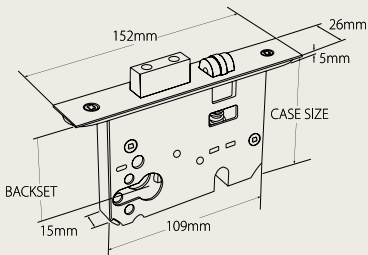

Finishes: SS, PB, BLK, OF

1149 Round Roller Lock Kit (Key/Key)
Includes 1140, 7020, 1147



1150 Round Roller Lock Kit (Key/Turn)
Includes 1140, 7020, 1148



Finishes: BN, SC, PB, BLK, OF



1157.1 Square Roller Lock Kit (Key/Key)
Includes 1140, 8102, 1147



1157.2 Square Roller Lock Kit (Key/Turn)
Includes 1140, 8102, 1148



Finishes: BN, SC, BLK, OF



Standard

1156 57mm backset 79mm case size

- Roller bolt operated by push or pull from either side
- Roller adjustable from the front

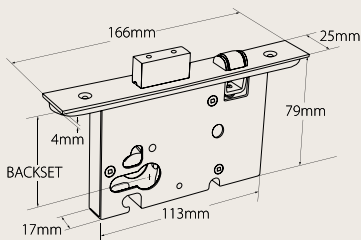

Finishes: SS



Refer to Page 127 for Rebate Kits, Extended Strikes and other lock accessories.

Locks, Latches, Cylinders > Nightlatches

Nightlatches

Heavy Duty

1215 57mm backset 77mm case size

- Latch retracts on either spindle drive or euro cylinder activation
- Quick reversal system for latch bolt
- Door can be set up with lever one side and pull handle and key cylinder the other
- Lockcase can be reversed in door depending on functions require
- Anti-thrust included in the mechanism

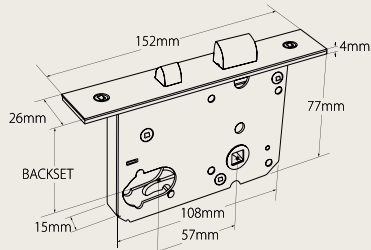

Finishes: SS



1216 Round Nightlatch Kit

Includes 1215, 7020, 1148



Finishes: BN, SC



1217 Square Deadbolt Kit

Includes 1215, 8102, 1148



Finishes: BN, SC



Standard

1197 47.5mm backset 69mm case size

- Latch retracts on either spindle drive or euro cylinder activation
- Hold back function for latch
- Easi-T quick reversal system for latch bolt
- Door can be set up with lever one side and pull handle and key cylinder the other
- Lockcase can be reversed in door depending on functions require

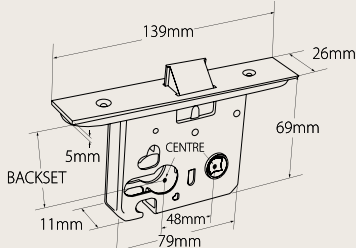

Finishes: SS



1204 Round Nightlatch Kit

Includes 1197, 7020, 1148



Finishes: BN, SC



1205 Square Deadbolt Kit

Includes 1197, 8102, 1148



Finishes: BN, SC



Refer to Page 127 for Rebate Kits, Extended Strikes and other lock accessories.

124

ZANDA
ARCHITECTURAL HARDWARE



Need technical assistance?
Call the experts on 1 300 ZANDA1

Locks, Latches, Cylinders > Mortice Locks

Mortice Locks

Euro 85

1142 45mm backset 71mm case size
1143 60mm backset 86mm case size

- Latch retracts on cylinder
- Features two stage bolt throw
- Quick reversible latch for easy on-site handling

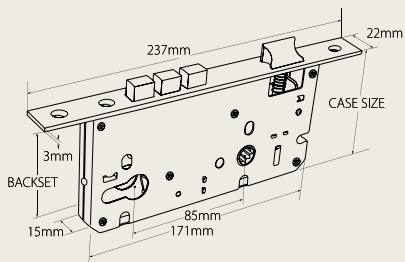

Finishes: SS, PB, BLK, OF

Euro 85 Narrow Backset

1226 30mm backset, 48mm case size

- Ideal for aluminium joinery and typically used with Astron longplate furniture (see page 44-51)
- Latch retracts on cylinder
- Quick reversible latch for easy on-site handling

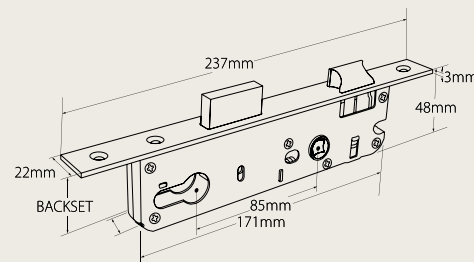

Finishes: SS

Euro 48

1114 45mm backset 66mm case size
1115 57mm backset 78mm case size

- Easi-T quick reversible system for latch

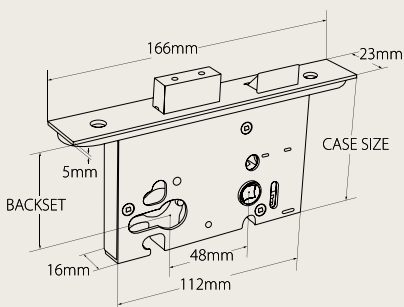

Finishes: SS, PB, BLK, OF

Double Turn Lock Kits



1182

1183

1184

Are you looking for a lock that:

- Won't blow open in the wind
- Doesn't need to be slammed closed
- Doesn't need adjustment once installed

Then look no further than these latest kits from Zanda. See page 28-29 for more information.

Finishes: BN, SC

Refer to Page 127 for Rebate Kits, Extended Strikes and other lock accessories.

Mortice Deadbolts

1130 45mm backset 66mm case size
1135 57mm backset 78mm case size

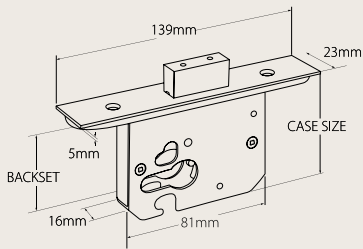

- Use with euro profile cylinder and escutcheons
- Force resistant, anti-drill and anti-saw security features



Finishes: SS, PB, OF

1219 Round Deadbolt Kit
Includes 1135, 7020, 1148



Finishes: BN, SC, PB



1220 Square Deadbolt Kit
Includes 1135, 8102, 1148



Finishes: BN, SC



Sliding Door Mortice Locks

1290 Claw Style
57mm backset,
76mm case size

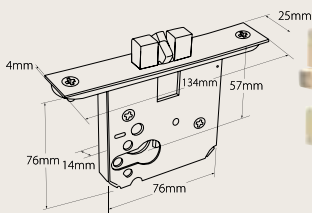

Finishes: SS, OF



1179 Hook Style
50mm backset,
67mm case size

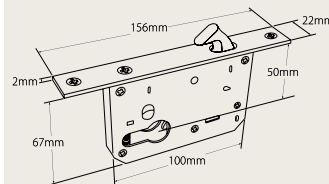

Finishes: SS, OF



Refer to Page 127 for Rebate Kits, Extended Strikes and other lock accessories.

Locks, Latches, Cylinders > Lock Accessories

Lock Accessories

Extended Strikes

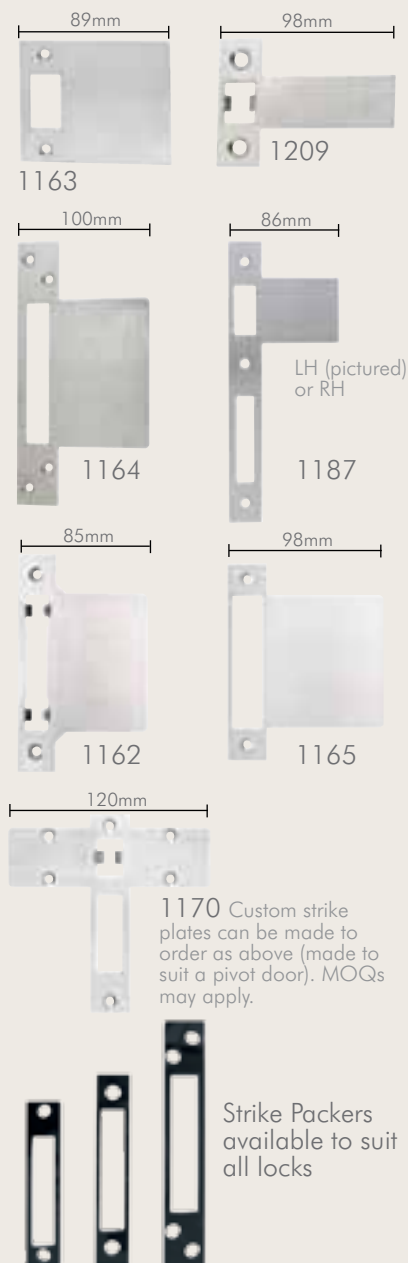

Lock / Latch Code No.	Rebate Kit Code No.	Extended Strike Code No.
1100	1102	1163
1101	1102A	1163
1106	1102	1163
1110	1109	1165
1111	1113	
1112	1113	1163
1114/1115	1105	1164
1120	1240	
1130	1132	
1131	1102A	1163
1135	1132	
1136	1109	1165
1139	1144	1162
1140	1144	1162
1142	1146	1187 (LH or RH)
1143	1146	1187 (LH or RH)
1149/1150	1146	1162
1150	1144	1162
1156	1181	1162
1157	1144	1162
1172	1174	1163
1173	1174	
1182	1105	1164
1183/1184	1146	1187 (LH or RH)
1195	1196	1209
1197	1198	1163
1204/1205	1198	1163
1213	1174	1163
1215	1218	1230
1216/1217	1218	1230
1219/1220	1132	
1226	1146	1187 (LH or RH)
1242	1174	1163
1317	1102A	
9011/9012	1102A	

Rebate Kits

1105
To suit
1114
1115
1182

- Full wrap around style for improved aesthetics
- Less vertical clearance between faceplate and striker for a tighter seal

Finishes: SS, PB

1181
To suit
1156 Roller Lock

- Full wrap around style for improved aesthetics
- Suits left or right hung doors 40 to 50mm thick

Finishes: SS



1146
To suit
1142
1143
1183
1184
1226

- Non handed

Finishes: SS, PB

1109
To suit
1110
1136

- Non handed

Finishes: SS, PB

1102A
To suit 1101, 1131, 1317
Triad Range, Jura Range,
Stealth Deadbolt

Finishes: SC

Pictured below with
1131 latch



Locks, Latches, Cylinders > Euro Cylinders

5 Pin Euro Cylinders

Double Cylinder (Key/Key)
1121 60mm length
1147 70mm length



Finishes: BN, SC, PB, BLK

Single Cylinder (Key/Turn)
1122 60mm length
1148 70mm length

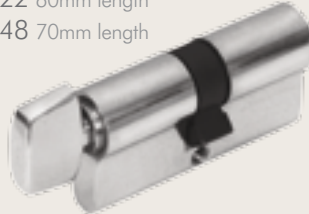

3 Pin Euro Cylinder

Double Cylinder (Key/Key)
1178 38mm length



Finishes: BN

Double Cylinder (Key/Key)
1224 90mm length



Finishes: BN, SC

Single Cylinder (Key/Turn)
1225 90mm length



Single Cylinder Key
1133 30mm length
1199 35mm length



Finishes: BN, SC, PB

Single Cylinder Snib
1134 30mm length
1200 35mm length



Measurements from cam to screw centers



6 Pin Euro Cylinders

- 6 Pin C4 key profile, suits security plugs
- Available keyed alike or keyed to differ
- Quality stainless steel grub screws for quick easy re-keying
- Constructed from high quality extruded brass
- Satin Chrome finish.

Double Cylinder
1246 6 pin, 70mm



Cylinder Turn
1247 6 pin, 70mm



Finishes: SC

FINISHES, CARE & MAINTENANCE

Standard Stock Finishes

Some finishes only available to certain products.



Special Finishes To Order

Available to most of the Zanda range, although some may be limited due to base metal of product. Special order products are non-returnable.



Natural Finishes available on solid brass items only. AB can be achieved on selected products (please enquire).



Care & Maintenance

Brass

The high polish of Zanda products is treated with a clear protective coating to provide durability. Brass, like sterling silver, will gradually tarnish and take on an antique appearance.

Atmospheric conditions, caustic agents such as paints, or scratches from sharp objects may cause the protective coating to crack or peel causing spotting and discolourations. However, the beauty of the metal can be maintained by taking a few simple steps. Initial care for brass requires only a quick rub with Windsor Wax Polish and light buffing with a soft cloth. You may prefer to do this weekly, especially in exterior, often used or damp environments.

"Blue Magic" Metal Polish is a quick, effective way of restoring mildly tarnished brassware. If heavy discolouration occurs the finish can be restored by stripping the remaining lacquer and polishing regularly with "Blue Magic". Alternatively let it age naturally to an antique finish. The beauty of solid brass is that it can always be restored to its original lustre.

Stainless Steel

To aid the longevity and appearance of quality Zanda stainless steel product we recommend that it is kept clean and a metal polish such as "Blue Magic" be applied periodically. Atmospheric conditions, salt deposits, acids, caustic agents, cement or dust on construction sites all have the potential to cause discolouration to the surface. If this occurs do not be concerned as usually this is not the stainless steel itself but particles clinging to its surface. The product can be revived by following the above maintenance procedure and repeating regularly. This small amount of routine care can only preserve the elegance of your Zanda stainless steel hardware.

Leather

Zanda's range of fine Italian leather products are protected by a urethane covering. Even so, they will need gentle care and maintenance to keep them in top condition. Clean leather products regularly with a soft, damp cloth as dirt and grime can act as abrasives on leather. Use an appropriate leather furniture conditioner periodically as required. This will depend on frequency of use of the hardware and proximity to sunlight. Wipe off food and body oils as soon as possible as they will oxidise and change the colour of the leather. Don't use water, cleaning solvents, soaps or ammonia based products to clean the leather; Water based stains will leave a permanent mark. This small amount of routine care can only preserve the elegance of your Zanda leather hardware.

Roman Brass / Natural Bronze / Oil Rubbed Bronze

The finish on Zanda's architectural brass products is an oxidation treatment which continues to age when it comes in contact with the atmosphere. Over time, the natural patina of the bronze finish will give way to an aged brass finish in heavy use areas. For care & maintenance, a gentle wipe with a damp cloth should keep your architectural brass hardware in top condition.

Black Iron

Zanda's Black Iron range has a powdercoated finish. Iron naturally oxidises, especially when exposed to the weather, and this can occur if the powdercoating is scratched or chipped. The iron itself will not deteriorate with oxidation, other than the discolouration of the surface, as the oxidation forms a skin on the surface unlike steel which continues to rust. Small chips can be touched up with a black wax crayon as the wax will provide weather protection. Larger areas can be restored with a black etch paint such as PA10.

5093 Wax Polish
50 gms



055 Blue Magic



1276 Threadlock

- » Medium Strength
- » Suitable for approx. 20 Grubscrews

OUR SERVICES

Keying

Zanda offer the following keying services:

Keying Alike (KA): Allows for a number of locks to be operated by the same key.

Keyed to Differ (KD): Each lock can only be opened by its own unique key.

Construction Keying (CKA): This system is used to allow contractors to gain entry to a building during construction but to prevent entry by the same contractors after the building has been occupied or handed over. On completion of the building, the owners key is activated rendering the construction key inoperative and preventing further entry by the contractor.

Master Keying (MKA): Each lock will have its own individual key which will not operate any other locks in the system, but where all locks can be operated by the one master key.

Grand Master Keying (GMKA): An extension of the master keyed system where each lock has its own individual key however the locks are divided into two or more groups. Each lock group is operated by a master key, and the entire system is operated by one grand master key.

Maison Keying (MAIKA): This is widely used in apartments, flats, offices, and hotels. Each unit has its own key which will not operate the locks to another unit but will however, operate the locks to communal entrances and service areas such as a gym.

Special Finishes

An addition to our beautiful standard finishes, Zanda offer a number of stunning high quality and durable special finish options on most of our products, giving your project that extra distinctive touch.

Our special finish service ensures your handles coordinate perfectly with your color scheme. Whatever your idea is, we have the ability for all the hardware in whichever finish you desire.



Training to boost your team

Zanda is renowned for their fun and inspirational training workshops. We have a range of enjoyable and insightful training programs to inspire your teams and ramp up product knowledge.



Installation Service

Watch this space for more information on our installation service and our Approved Installers program, due November 2015.



OUR SERVICES

Dedicated Account & Project Managers

Ordering and specifying architectural hardware can be a complicated process. Our experienced account and project managers are equipped with the knowledge and expertise so your ordering process or project can be completed seamlessly. Not only are they equipped with exceptional customer service skills, they offer high levels of integrity, an excellent work ethic and a commitment to go beyond what our customers would ever expect. Contact us to request a dedicated account manager or a project manager for an upcoming job.



Door Hardware Scheduling

Zanda offers a full door hardware scheduling service for builders, architects and designers to save you time and money throughout your planning process. This ensures that all items are compatible together, Australian regulations are met, every door type and configuration is accounted for, the finishes are consistent throughout your project and potential pitfalls are prevented. Just provide us with your floor plans and we'll prepare a detailed door by door schedule that fully addresses your requirements.



Door-set Packaging

Let us do the work. Where necessary, your hardware can be delivered pre-packed in door by door packages. Each individual door will have its own clearly marked box that contains all the hardware items required for that door. You can call up your deliveries in units or areas. This valuable service saves on installation time, reduces confusion and errors, and eliminates product getting lost or damaged on site.



Technical Support

Our team pride themselves at being experts in their field. We place great emphasis on phone skills and our staff are regularly put through in-house and external training programs to further their customer service skills and technical product knowledge. What's more, we guarantee we'll answer your call within 10 seconds during standard business hours. So go on, call our team of experts on **1300 ZANDA1**.



DISPLAYS & MERCHANDISING

Stocked Display Boards - Re-energize your showroom



Flush Pull Block

Stealth Block

Astron Working Block
Choose any six Astron handles of your choice

Combination Board
Includes Astron, Futura & Jura handles (900mm width x 800mm height)

Verve Lock Kit Block

Double Turn Lock Kit Block

Astron Longplate Lock Block
Choose any two longplates of your choice

Cavity Suite Block
(see page 68)

Talk to us about a Custom Display Board

Where applicable, Zanda can custom make display boards to suit your unique showroom space allowing your store to stand out. Call us on **1300 ZANDA1** for more information.

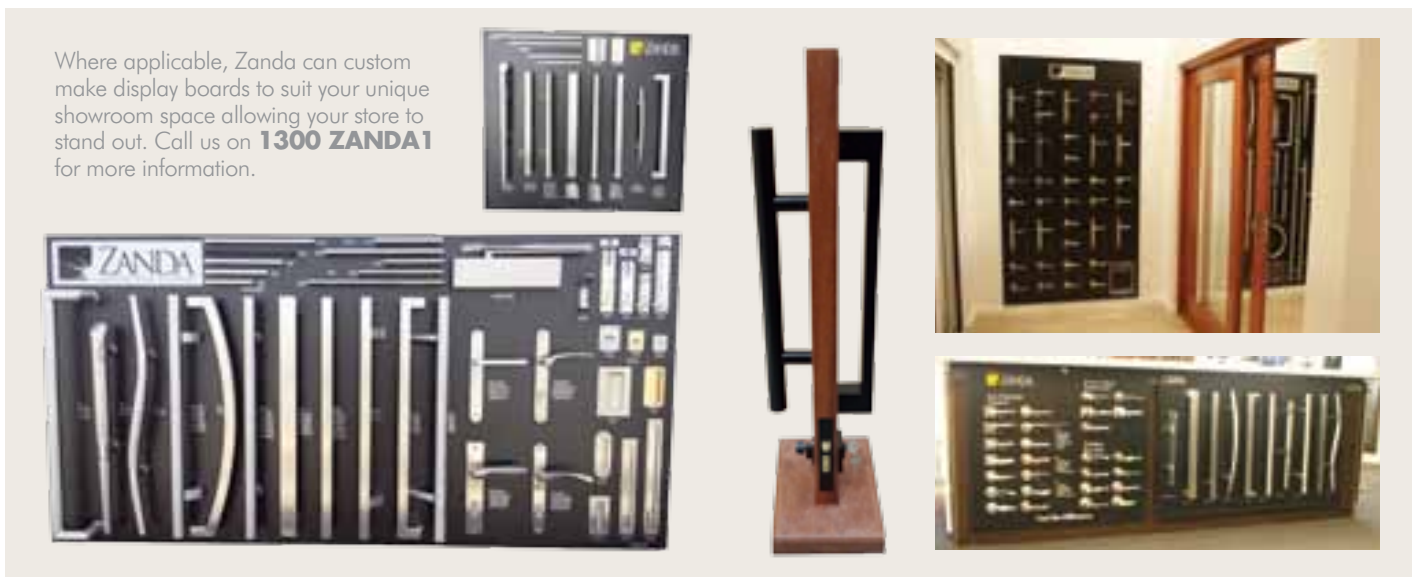

DISPLAYS & MERCHANDISING

Brochures & Price Books



CC.15 Comprehensive Catalogue

Zanda's complete product range including full dimensions and details of every product.



HB.2013 Handout Brochure

Fantastic handout brochure giving a general overview of the majority of our products.



RPL.13 Rutland

Excellent overview of our Rutland Door Control products. All details are clearly laid out and diagrams are included of every product.



IPL.15 Illustrated Price List

Easiest to read price list in the industry making ordering and specifying extremely simple. Everything is pictured and clearly laid out including a number of kit set codes and bulk quantity rates on certain lines.

Merchandising Material - to boost sales

Zanda understands that to drive consumer demand, products need to be displayed well. We are confident that when a purchaser sees Zanda branding on display, they immediately know that the product will meet the Zanda standards of highest quality and performance.

Zanda offers a range of branding options for both printed and digital marketing collateral. This includes

- Co-branded brochures and flyers
- Corflute Signs
- One way window signage
- Authorized Dealer stickers
- Posters
- Brochure Holders
- Merchandising Systems
- Pullup Banners
- Co-branded uniforms

Call us on **1300 ZANDA1** for more information on how we can help you with our merchandising.



Merchandising Systems



Corflute Signs



Insist on Zanda Posters
A1, A2 or A3 sizes

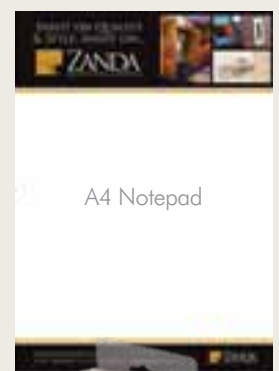

A4 Notepad



Impressive Packaging

Glossary of Terms

Active Door The door in a double door set that is opened first and to which a functionable lockset is applied.

Backcheck A function on a door closer which provides a cushioning effect when the door is forcibly thrown open. This does not serve as a substitute for a door stop.

Backset The horizontal distance from the face of the lock to the centre of the bore or cylinder hole.

Case The housing of a lock, latch or bolt

Closing Speed The speed at which the door closes from the fully open position to 15-0. This can be adjusted by the valve on most door closers.

Cylinder Barrel A cylindrical portion of the cylinder that rotates when the correct key is used.

Cylinder The assembly incorporating the key operated mechanism.

Deadbolt A lock bolt having no spring action and is operated by a key or turnsnib. When locked the bolt cannot be returned by end pressure.

Delayed Action Provides prolonged closing time to assist the passage of wheel chairs, less abled people and people with prams, shopping etc.

Double Cylinder A locking cylinder barrel controlled by a key on both the outside and inside.

Dummy Set A non functioning handle for one side of the door that has no latching or locking function. It is surface mounted to a door simply so the door has a handle to pull it open. They are generally used on closet, wardrobe or linen cupboard doors with a catch.

Edge Pull A recessed pull morticed into the edge of a sliding door which enables a user to pull out a door that is completely inside a cavity.

Fixed Pin Hinge A hinge in which the pin is fastened permanently in place, preventing separation of the two leaves.

Flush Bolt A bolt recessed flush into the edge of the inactive leaf of a pair of doors at the top and bottom to secure a door.

Handed Products A product designed or assembled for use only on right hand doors or only left hand doors, but not both (see handing below).

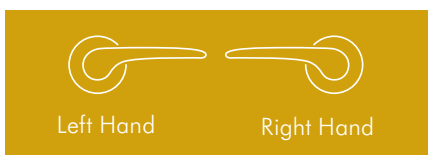

Hold-open A function on a door closer which enables a door to be held in the opened position until released.

Inactive Door The door in a double door set that does not contain a latch, but instead is bolted at the top and bottom to hold it stationary when shut.

Indicator Bolt A slide-action bolt installed in areas where privacy is desired (such as toilets and bathrooms) which provides visual indication that the room is occupied or vacant.

Jamb Vertical posts or pieces that together form the sides of a door or window frame.

Latch The fastening on a door that fits into the strike slot on a door jamb and is retracted from either side by the handle.

Latching Speed The speed at which the door closes from 15-0. This can be adjusted by the valve on most door closers.

Loose Pin Hinge A hinge having a removable pin to permit the two leaves of the hinge to be separated.

Mortice Lock A lock designed to be recessed into the edge of a door, rather than being mounted to its surface. It combines the latching and locking mechanism into one unit.

Nightlatch A lock with a spring activated latchbolt. Useful where you want to lock a door behind you without a key.

Non-handed The ability to reverse the product or key component to suit left or right-hand installation.

Passage Set Include a lever set and non-lockable latch bolt that allows free access through the door in both directions at all times. Appropriate for internal doors that never need to be locked (Dining Room, Laundry etc).

Power Adjustable By Spring This is where the power size on a closer can be adjusted by turning the allen key, the plates are moved in the body, compressing the spring, which increases the power size.

Power Adjustable by Position This is where the power size on a closer can be adjustable by their position on the door. You increase the strength by positioning the closer away from the hinge or pivot centre.

Privacy Set A term for locks used on bathroom and bedroom doors having an inside button or turn knob to lock the outside handle and usually an emergency function which will unlock the set from the outside.

Rebated Door A door where the leading edge is stepped.

Reversible Lock A lock with the components that can be readily adapted to enable the lock to suit door of either hand, opening in or out.

Rose The decorative backplate attached to the door lever that screws to the door surface.

Single Cylinder A locking barrel controlled by a key on the outside and a turnsnib on the inside for easy exit in an emergency.

Sliding Door A type of door installed on a sliding track that slides into a hollowed space or along a wall. Ideal for space minimisation as they eliminate the necessity to maintain clearance for the action of a swinging door. Sometimes referred to as a Pocket Door.

Spindle The drive shaft connecting the knob or lever to the latch or lock mechanism to operate the bolt.

Split Spindle A spindle having a joint in the centre to allow each side of a handle to operate independently.

Strike A metal plate that receives the door bolt or latch in the door jamb when the door is closed. Also referred to as a Faceplate or Keeper.

Abbreviations

CRS	Screw/Bolt Centres
OA	Overall Length
PIC	As Pictured
B/S	Lock Backset
C/S	Lock Case Size O/A
W	Width
P	Projection
PA	Parallel Arm

NEED TECHNICAL ASSISTANCE?
Call the experts on
1300 ZANDA 1

PRODUCT INDEX

135



CODE PAGE	CODE PAGE	CODE PAGE	CODE PAGE	CODE PAGE	CODE PAGE	CODE PAGE	CODE PAGE	CODE PAGE	CODE PAGE										
1100	118	1199	128	5214	74	5932	73	6385	108	7038	47	7165	25	9005	61	10064	56	16054	102
1101	118	1200	128	5224	74	5933	73	6386	108	7039	51	7166	25	9006	61	10404	75	16057	102
1102	127	1204	123	5225	74	5934	73	6387	109	7040	51	7300	11	9007	61	10405	75	16059	102
1105	127	1205	123	5226	74	5936	73	6388	109	7041	51	7301	11	9008	61	10406	75	AB.1	89
1106	118	1209	127	5228	64	5937	73	6389	109	7042	51	7302	11	9009	61	10407	75	CP.70	95
1109	127	1209	127	5229	70	5938	73	6390	109	7043	51	7303	11	9010	61	10408	75	CSA.106	90
1110	119	1213	118	5235	75	5939	73	6391	109	7044	51	7306	9	9011	62	10409	75	DF.70	95
1111	119	1215	123	5239	74	6006	115	6392	107	7045	49	7307	9	9012	62	10410	75	DP.34	83
1112	118	1216	123	5240	70	6041	115	6393	107	7046	47	7308	9	9018	60	10411	75	DP.90	85
1113	127	1217	123	5241	64	6045	114	6394	107	7047	51	7309	9	9019	60	10415	79	DP.95	87
1114	125	1218	127	5242	64	6047	115	6395	107	7048	51	7310	9	9020	60	10423	75	DP.96	89
1115	125	1219	126	5243	80	6048	115	6396	109	7049	49	7313	44	9022	60	10429	75	DT.80	96
1119	77	1220	126	5244	100	6049	115	6397	109	7050	49	7314	44	9023	60	10500	71	ELA.80	96
1120	119	1221	30	5249	70	6055	115	6398	109	7051	49	7315	44	9024	60	10684	56	ES.70.10	95
1121	128	1224	128	5250	80	6061	114	6399	109	7052	49	7316	44	9026	60	10687	77	ES.70.13	95
1122	128	1225	128	5251	100	6062	114	6413	107	7053	49	7317	44	9027	60	11500	58	ES.70.15	95
1130	126	1226	125	5253	100	6064	114	6414	107	7054	15	7318	43	9028	60	11501	58	ES.70.18	95
1131	118	1230	127	5254	100	6067	109	6415	107	7055	15	7319	43	9030	60	11502	58	ES.70.23	95
1132	127	1231	30	5255	100	6068	109	6424	104	7056	78	7320	9,43	9031	60	11503	58	ES.70.3	95
1133	128	1232	30	5256	70	6069	109	6425	104	7057	47	7321	43	9032	60	11504	58	ES.70.48	95
1134	128	1238	30	5257	64	6071	109	6426	104	7058	47	8003	78	9034	56	11505	58	ES.70.5	95
1135	126	1240	30	5258	71	6072	109	6427	104	7059	47	8016	79	9035	56	11506	58	ES.70.8	95
1136	119	1240	127	5259	64	6073	109	6428	104	7060	47	8055	79	9090	61	11507	58	FBA.1	83
1137	77	1242	118	5260	65	6074	107	6429	104	7061	47	8067	71	9091	61	11508	58	FBA.3	89
1139	122	1246	128	5261	65	6075	107	6430	104	7063	13	8088	64	9092	61	11509	58	G5	98
1140	122	1247	128	5262	70	6076	107	6431	104	7064	18	8089	79	9093	61	11510	58	G500	98
1141	78	1248	29	5263	71	6079	113	6432	103	7065	18	8090	44	9094	61	11511	58	G555	98
1142	125	1249	29	5264	70	6080	113	6433	103	7066	15	8091	44	9100	62	11516	58	HDF.34	83
1143	125	1250	29	5265	70	6082	113	6434	103	7067	79	8099	42	9101	62	11517	58	HMC.70	95
1144	127	1251	29	5267	64	6083	113	6435	103	7069	24	8100	42	9102	62	11518	58	HOA.1	83
1146	127	1252	26	5270	74	6084	113	6436	103	7070	24	8101	79	9103	62	11519	58	HOA.106	90
1147	128	1253	26	5271	74	6086	113	6437	103	7071	79	8102	78	9104	62	11520	58	HOA.2	85
1148	128	1254	26	5272	74	6087	114	6438	103	7072	79	8103	44	9110	62	11521	58	ITS.11204	93
1149	122	1255	26	5273	74	6088	114	6439	103	7076	79	8104	79	9111	62	11522	58	PAB.1	83
1150	122	1256	26	5274	70	6100	115	6500	115	7080	49	8105	68	9112	62	12500	100	PS.110	97
1151	52	1257	26	5275	80	6101	115	6501	115	7081	47	8106	68	9113	62	12502	100	PS.170	97
1152	77	1258	28	5276	80	6102	115	6502	115	7082	51	8107	68	9114	62	12505	100	PS.180	97
1156	122	1259	28	5277	71	6103	115	6503	115	7083	51	8109	42	9301	35	12520	100	PS.210	97
1157	27	1267	118	5278	70	6104	115	6504	115	7084	49	8110	42	9305	35	13500	23	PS.240	97
1162	127	1268	118	5279	80	6105	115	6510	115	7085	47	8113	79	9306	35	13501	24	PS.260	97
1162	127	1269	67	5283	80	6108	108	6511	115	7092	13	8114	42	9307	35	14000	75	SA.1	85
1163	127	1270	67	5284	80	6110	112	6512	115	7093	13	8115	42	9315	37	14001	80	SA.2.DAX	93
1163	127	1271	67	5285	80	6149	114	6513	115	7094	13	8117	79	9317	37	14002	80	SA.2.SAX	91
1164	127	1276	129	5304	67	6300	114	6514	115	7095	15	8118	79	9321	37	14008	70	SA.CS	91
1164	127	1290	126	5305	67	6314	107	6515	115	7096	15	8120	118	9322	37	14009	70	SA.HO	91
1165	127	1317	121	5306	67	6315	107	6516	115	7097	15	8121	118	9325	38	14010	70	SL.106	90
1165	127	2034	78	5308	75	6316	107	6517	115	7098	17	8122	118	10010	55	16000	105	SL.34	83
1166	78	3034	78	5320	67	6322	113	6518	115	7099	17	8123	118	10011	55	16001	105	SLA.80	96
1167	78	5013	100	5321	67	6323	113	6519	115	7100	17	8124	118	10012	55	16002	105	SP.1	83
1168	78	5014	100	5322	67	6324	109	6520	115	7101	17	8125	118	10013	55	16003	105	SQ.90	85
1170	127	5015	77	5326	68	6325	109	6521	115	7102	17	8126	42	10014	55	16004	105	SR.114	91
1171	78	5016	77	5327	68	6326	109	6522	115	7103	23	8128	41	10020	55	16005	105	SR.90	85
1172	118	5024	78	5328	68	6327	109	6523	115	7104	23	8129	41	10021	55	16006	105	SR.96	89
1173	119	5055	100	5330	68	6328	113	6524	115	7105	45	8130	41	10022	55	16007	105	SSLA.80	96
1174	127	5057	80	5331	68	6329	113	6824	116	7106	45	8131	41	10023	55	16008	105	STA.1	83
1175	74	5062	70	5332	68	6333	107	6825	116	7107	45	8132	41	10024	55	16009	105	STA.2	85
1178	128	5063	71	5333	64	6334	107	6826	116	7108	45	8133	41	10030	54	16010	105	STA.3	89
1179	126	5093	129	5901	73	6335	107	6827	116	7109	45	8134	41	10031	54	16011	105	TH.107	97
1180	77	5133	71	5903	73	6336	111	7015	49	7110	45	8135	41	10032	54	16012	105	TS.10106	90
1181	127	5142	80	5904	73	6337	111	7019	47	7112	45	8136	78	10033	54	16013	105	TS.11204	91
1181	127	5143	80	5905	73	6338	111	7020	78	7113	45	8137	44	10034	54	16014	105	TS.3204	83
1182	28	5144	80	5908	73	6339	111	7022	51	7114	45	8138	44	10040	56	16015	105	TS.7002	95
1183	28	5154	64	5909	73	6340	111	7025	13	7115	45	8139	79	10041	56	16016	105	TS.7003	95
1184	28	5155	64	5910	73	6341	112	7026	13	7116	45	8140	78	10042	56	16017	105	TS.7004	95
1187	127	5177	64	5911	73	6345	112	7027	19	7117	45	8146	78	10043	56	16025	107	TS.8002	96
1187	127	5182	64	5920	73	6351	112	7028	19	7128	21	8147	79	10044	56	16026	107	TS.8003	96
1188	65	5207	74	5921	73	6352	112	7030	51	7129	21	8160	33	10050	54	16030	102	TS.8004	96
1189	65	5208	74	5922	73	6353	112	7032	79	7130	21	8162	33	10051	54	16031	102	TS.9204	85
1191	77	5209	74	5925	73	6354	112	7033	49	7131	21	8170	43	10052	54	16032	102	TS.9205	87
1195	119	5210	74	5926	73	6355	112	7034	49	7142	19	8179	33	10053	54	16046	114	TS.9206	89
1196	127	5211	74	5927	73	6382	111	7035	49	7143	19	8180	33	10054	54	16050	102		
1197	123																		



Perth - Melbourne - Sydney - Adelaide
Telephone 1300 926 321
Facsimile 1300 926 322
Email sales@zanda.com.au
www.zanda.com.au

© 2015 Zanda Achitectural Hardware

Zanda Architectural (Zanda) disclaims all liability for any statements or information that is erroneous or incomplete contained in any brochure, datasheet or in any other communication relating to any product Zanda sells, supplies, manufactures or otherwise deals with. Although Zanda endeavors to provide useful information, the buyer is responsible for independently satisfying itself as to the information provided. Zanda does not guarantee that any goods will be fit for purpose or suitable for any particular application or use. It is the buyer's responsibility to independently determine the suitability of any products and to test and verify the same. In all cases the supply of goods is based on Zanda's Terms and Conditions of Sale.

AVAILABLE FROM: